



Cisco D9865 Satellite Receiver Software Version 2.15 Installation and Configuration Guide

January 2013

Americas Headquarters

Cisco Systems, Inc.
170 West Tasman Drive
San Jose, CA 95134-1706
USA
<http://www.cisco.com>
Tel: 408 526-4000
800 553-NETS (6387)
Fax: 408 527-0883

THE SPECIFICATIONS AND INFORMATION REGARDING THE PRODUCTS IN THIS MANUAL ARE SUBJECT TO CHANGE WITHOUT NOTICE. ALL STATEMENTS, INFORMATION, AND RECOMMENDATIONS IN THIS MANUAL ARE BELIEVED TO BE ACCURATE BUT ARE PRESENTED WITHOUT WARRANTY OF ANY KIND, EXPRESS OR IMPLIED. USERS MUST TAKE FULL RESPONSIBILITY FOR THEIR APPLICATION OF ANY PRODUCTS.

THE SOFTWARE LICENSE AND LIMITED WARRANTY FOR THE ACCOMPANYING PRODUCT ARE SET FORTH IN THE INFORMATION PACKET THAT SHIPPED WITH THE PRODUCT AND ARE INCORPORATED HEREIN BY THIS REFERENCE. IF YOU ARE UNABLE TO LOCATE THE SOFTWARE LICENSE OR LIMITED WARRANTY, CONTACT YOUR CISCO REPRESENTATIVE FOR A COPY.

This equipment has been tested and found to comply with the limits for a Class B digital device, pursuant to part 15 of the FCC rules. These limits are designed to provide reasonable protection against harmful interference in a residential installation. This equipment generates, uses and can radiate radio frequency energy and, if not installed and used in accordance with the instructions, may cause harmful interference to radio communications. However, there is no guarantee that interference will not occur in a particular installation. If the equipment causes interference to radio or television reception, which can be determined by turning the equipment off and on, users are encouraged to try to correct the interference by using one or more of the following measures:

- Reorient or relocate the receiving antenna.
- Increase the separation between the equipment and receiver.
- Connect the equipment into an outlet on a circuit different from that to which the receiver is connected.
- Consult the dealer or an experienced radio/TV technician for help.

Modifications to this product not authorized by Cisco could void the FCC approval and negate your authority to operate the product.

This Class B digital apparatus complies with Canadian ICES-003.

Cet appareil numérique de la classe B est conforme à la norme NMB-003 du Canada.

The Cisco implementation of TCP header compression is an adaptation of a program developed by the University of California, Berkeley (UCB) as part of UCB's public domain version of the UNIX operating system. All rights reserved. Copyright © 1981, Regents of the University of California.

NOTWITHSTANDING ANY OTHER WARRANTY HEREIN, ALL DOCUMENT FILES AND SOFTWARE OF THESE SUPPLIERS ARE PROVIDED "AS IS" WITH ALL FAULTS. CISCO AND THE ABOVE-NAMED SUPPLIERS DISCLAIM ALL WARRANTIES, EXPRESSED OR IMPLIED, INCLUDING, WITHOUT LIMITATION, THOSE OF MERCHANTABILITY, FITNESS FOR A PARTICULAR PURPOSE AND NONINFRINGEMENT OR ARISING FROM A COURSE OF DEALING, USAGE, OR TRADE PRACTICE.

IN NO EVENT SHALL CISCO OR ITS SUPPLIERS BE LIABLE FOR ANY INDIRECT, SPECIAL, CONSEQUENTIAL, OR INCIDENTAL DAMAGES, INCLUDING, WITHOUT LIMITATION, LOST PROFITS OR LOSS OR DAMAGE TO DATA ARISING OUT OF THE USE OR INABILITY TO USE THIS MANUAL, EVEN IF CISCO OR ITS SUPPLIERS HAVE BEEN ADVISED OF THE POSSIBILITY OF SUCH DAMAGES.



Cisco and the Cisco logo are trademarks or registered trademarks of Cisco and/or its affiliates in the U.S. and other countries. To view a list of Cisco trademarks, go to this URL: www.cisco.com/go/trademarks. Third-party trademarks mentioned are the property of their respective owners. The use of the word partner does not imply a partnership relationship between Cisco and any other company. (1110R)

Any Internet Protocol (IP) addresses and phone numbers used in this document are not intended to be actual addresses and phone numbers. Any examples, command display output, network topology diagrams, and other figures included in the document are shown for illustrative purposes only. Any use of actual IP addresses or phone numbers in illustrative content is unintentional and coincidental.

Cisco D9865 Satellite Receiver Installation and Configuration Guide
© 2010-2013 Cisco Systems, Inc. All rights reserved.



Safety Precautions

This symbol alerts you to the presence of uninsulated dangerous voltage inside the product enclosure that poses a risk of electric shock.		CAUTION RISK OF ELECTRICAL SHOCK DO NOT OPEN	 This symbol alerts you to important operating and maintenance (servicing) instructions included with this product.
CAUTION TO REDUCE THE RISK OF ELECTRICAL SHOCK, DO NOT REMOVE COVERS FROM THIS UNIT. NO USER-SERVICEABLE PARTS INSIDE. REFER SERVICING TO QUALIFIED PERSONNEL. SEE ADDITIONAL SAFETY INSTRUCTIONS BELOW.			
WARNING TO REDUCE THE RISK OF ELECTRICAL SHOCK, DO NOT EXPOSE THIS PRODUCT TO RAIN OR MOISTURE.			

1. Read these instructions.
2. Keep these instructions.
3. Heed all warnings.
4. Follow all instructions.
5. Do not use this apparatus near water.
6. Clean only with dry cloth.
7. Do not block any ventilation openings. Install in accordance with the manufacturer's instructions.
8. Do not install near any heat sources such as radiators, heat registers, stoves, or other apparatus (including amplifiers) that produce heat.
9. Do not defeat the safety purpose of the polarized or grounding-type plug. A polarized plug has two blades with one wider than the other. A grounding type plug has two blades and a third grounding prong. The wide blade or the third prong is provided for your safety. If the provided plug does not fit into your outlet, consult an electrician for replacement of the obsolete outlet.
10. Protect the power cord from being walked on or pinched particularly at plugs, convenience receptacles, and the point where they exit from the apparatus.
11. Only use attachments/accessories specified by the manufacturer.

12. Use only with the cart, stand, tripod, bracket, or table specified by the manufacturer, or sold with the apparatus. When a cart is used, use caution when moving the cart/apparatus combination to avoid injury from tip-over.

PORTABLE CART WARNING



13. Unplug this apparatus during lightning storms or when unused for long periods of time.
14. Refer all servicing to qualified service personnel. Servicing is required when the apparatus has been damaged in any way, such as power-supply cord or plug is damaged, liquid has been spilled or objects have fallen into the apparatus, the apparatus has been exposed to rain or moisture, does not operate normally, or has been dropped.
15. Do not expose this apparatus to dripping or splashing and ensure that no objects filled with liquids, such as vases, are placed on the apparatus.
16. To completely disconnect this apparatus from the AC Mains, disconnect the power supply cord plug from the AC receptacle.
17. The mains plug of the power supply cord shall remain readily operable.
18. Damage Requiring Service: Unplug this product from the wall outlet and refer servicing to qualified service personnel under the following conditions:
 - a. When the power-supply cord or plug is damaged.
 - b. If liquid has been spilled, or objects have fallen into the product.
 - c. If the product has been exposed to rain or water.
 - d. If the product does not operate normally by following the operating instructions. Adjust only those controls that are covered by the operating instructions as an improper adjustment of other controls may result in damage and will often require extensive work by a qualified technician to restore the product to its normal operation.
 - e. If the product has been dropped or damaged in any way.
 - f. The product exhibits a distinct change in performance.
19. Replacement Parts: When replacement parts are required, be sure the service technician uses replacement parts specified by Cisco, or parts having the same operating characteristics as the original parts. Unauthorized part substitutions made may result in fire, electric shock or other hazards.
20. Safety Check: Upon completion of any service or repairs made to this product, ask the service technician to perform safety checks to determine that the product is in safe operating condition.
21. Outdoor Antenna Grounding: If an outside antenna or cable system is connected to this product, ensure that the antenna or cable system is properly grounded to provide protection against voltage surges and built-up static charges. Appropriate sections of the National Electrical Code (NFPA 1990) provide information with respect to proper grounding of the mast and supporting structure,

grounding of the lead-in wire to an antenna discharge unit, connection to grounding electrodes, and requirements for the grounding electrode (see Satellite Receiver and Satellite Antenna Satellite Antenna).

Satellite Receiver & Satellite Antenna Grounding

Before you can operate your satellite receiver system, both the satellite receiver chassis and the satellite antenna LNB connection(s) must be properly grounded. For information about grounding your satellite receiver, also referred to as “receiver”, and satellite antenna follow:

Grounding the receiver: The receiver ground connection is made from the shield (multi-strand braided shield surrounding the center conductor of the coaxial cable) conductor attached to the RF coaxial cable “F” connector (rear panel RF IN input) to an external grounding rod via a receiver/antenna grounding block. A separate grounding wire connects the grounding block (and the satellite antenna LNB grounding block) to the grounding rod.

Grounding the LNB and/or VHF/UHF antenna: The antenna ground connection is made from the satellite LNB/antenna ground and/or the VHF/UHF terrestrial antenna discharge unit to an external grounding rod via a receiver/antenna grounding block.

General grounding information: The actual ground/cable connections made depend on your site installation requirements, and on the type of satellite antenna and/or VHF/UHF terrestrial antenna you have. If your satellite antenna installation includes a dual-port LNB, both RF coaxial cables must be routed to the grounding block. When connecting RF coaxial antenna cables to the grounding block, looping the antenna cables as shown in the accompanying figure helps to direct moisture away from the grounding block. Always choose the shortest route possible when connecting RF coaxial cables to the receiver/antenna grounding block and when connecting the grounding wire(s) to the grounding rod.



Caution

Each ground connection must be made using a single (continuous) piece of wire. Never splice two wires together when making a ground connection. Corrosion and weathering can cause a poor electrical connection at the splice which can lead to an ineffective and dangerous ground condition.

Figure 1 Outdoor Antenna Grounding

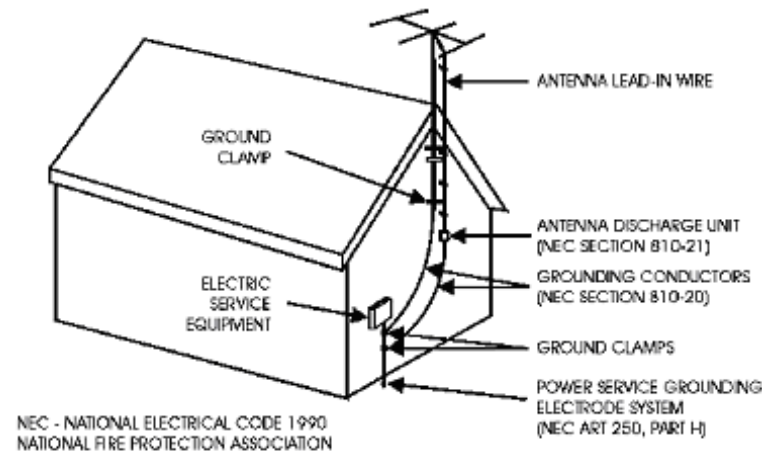

TO CATV SYSTEM INSTALLER

This reminder is provided to call the CATV system installer's attention to Article 820-40 of the National Electrical Code (NEC) that provides guidelines for proper grounding, and in particular, specifies that the cable ground shall be connected to the grounding system of the building, as close to the point of entry as practical.

**Caution**

Install this product on a flat surface only, ensuring that all four rubber feet are making full contact with the mounting surface. During normal operation, it is recommended that physical contact be limited to using the front panel buttons only. Do not place any other equipment directly on top of the receiver, and prevent foreign objects from coming into direct contact with the chassis. Subjecting this product to abnormal impact may result in momentary interruption of video service.

Safety Precautions (EU Market)

Mesures de Sécurité

Sicherheitmassnahmen

Precauciones de Seguridad

Warning

To prevent fire or electric shock:

- Do not expose this apparatus to rain or moisture.
- Avoid spilling liquids on or near this apparatus.
- Do not open the top cover of this apparatus.
- Do not push objects through openings in this apparatus.
- Refer servicing to qualified personnel only.

Attention

Afin d'éviter tout incendie ou choc électrique:

- Ne laissez pas cet appareil sous la pluie ou dans un endroit humide.
- Ne renversez pas de liquide sur ou à proximité de l'appareil.
- N'ouvrez pas le couvercle supérieur de l'appareil.
- N'insérez pas d'objet dans les ouvertures de l'appareil.
- Faites réparer votre appareil par une personne qualifiée.

Warnung

Um Feuer oder elektrischen Schock zu vermeiden:

- Keiner Nässe oder Feuchtigkeit aussetzen.
- Keine Flüssigkeiten auf oder in der Nähe des Gerätes verschütten.
- Den oberen Deckel nicht öffnen.

- Keine Gegenstände in die Geräteöffnungen stecken.
- Arbeiten am Gerät nur von qualifiziertem.

Advertencia

Para prevenir incendio o una descarga eléctrica:

- No esponga este aparato a la lluvia o a la humedad.
- Evite derramar líquidos en o cerca del aparato.
- No abra la cubierta superior de este aparato.
- No introduzca objetos a través de las aberturas de este aparato.
- Mandelo a servicio únicamente donde existe personal calificado.

Caution

- To protect this apparatus against damage from lightning storms and power-line surges, or when you are not using this apparatus for a long period of time, disconnect the power cord from the AC outlet.
- To disconnect the cord, pull it out by grasping the plug. Never pull the cord itself. Additionally, never walk on, place objects on, or pinch the power cord.
- The top cover on this apparatus has openings for ventilation to protect it from overheating. To ensure reliable operation, do not block or cover these openings by placing this apparatus on a bed, sofa, rug, or any similar surface, or by placing entertainment apparatus, lamps, books, or other objects on the top cover.
- Additionally, never place this apparatus near or over a radiator or heat register, or a built-in installation, such as a bookcase or rack, unless the installation provides proper ventilation.
- Locate this apparatus on a stable, vibration-free surface capable of supporting its weight and size.

Précautions à prendre

- Afin de protéger votre appareil des orages et des surtensions de courant ou si vous ne l'utilisez pas pendant une période prolongée, débranchez de la prise électrique du secteur.
- Pour débrancher, tirez sur la prise. Ne tirez jamais sur le cordon secteur. En outre, ne marchez jamais sur le cordon, ne placez pas d'objet dessus et ne le coincez pas.
- Le couvercle supérieur de cet appareil comprend des ouvertures pour la ventilation afin d'éviter qu'il ne chauffe trop. Pour assurer un bon fonctionnement, ne bloquez pas ou ne couvrez pas ces ouvertures en plaçant cet appareil sur un lit, un sofa, un tapis ou toute autre surface semblable. Ne posez pas de lampes, livres ou tout autre objet sur le couvercle supérieur.
- De plus, il ne faut jamais mettre cet appareil près d'un radiateur ou tout autre élément dégageant de la chaleur. Ne l'incorporez pas dans une installation comme une bibliothèque, une étagère, à moins que l'installation offre une ventilation appropriée.
- Installez cet appareil sur une surface dégagée, stable et sans vibration capable de supporter son poids et sa taille.

Vorsicht

- Um dieses Gerät vor Blitzschlag bzw. Stromüberladung zu schützen, oder wenn das Gerät längere Zeit nicht benutzt wird, soll der Stecker aus der Steckdose gezogen werden.
- Zum Abschalten immer am Stecker selbst und nie am Kabel ziehen. Außerdem nie darauf treten, einen Gegenstand darauf legen oder das Kabel drücken.
- Die Oberseite des Gerätes hat Ventilationsöffnungen, die das Gerät vor Überhitzung schützen. Um einwandfreies Funktionieren zu gewährleisten, dürfen diese Öffnungen nicht blockiert oder verdeckt werden (z.B. nicht auf ein Bett, Sofa, Teppich oder ähnliche Unterlagen stellen, oder Lampen, Bücher oder ähnliches auf das Gerät stellen).
- Außerdem soll dieses Gerät nie in der Nähe einer Heizquelle stehen. Vermeiden Sie, das Gerät in einem geschlossenen Platz aufzustellen, z. B. Schrank, wo ausreichende Ventilation nicht möglich ist.
- Stellen Sie das Gerät auf eine stabile und schwingungsfreie Unterlage, die für das Gerät groß genug ist.

Precaucion

- Para proteger este aparato contra daños producidos por tormentas eléctricas y pulsaciones de energía eléctrica, o cuando no use este aparato por largo tiempo, desconéctelo del tomacorriente de CA.
- Para desconectar el cable, tómelo del enchufe y desconéctelo. Nunca tire del cable directamente. Asimismo, nunca apriete, pise, o coloque objetos sobre el cable.
- La cubierta superior de este aparato tiene aberturas de ventilación para evitar que se recaliente. Para asegurar una operación confiable, no bloquee o cubra estas aberturas colocando este aparato sobre una cama, sofá, alfombra o cualquier superficie similar, o colocando sobre la cubierta superior artefactos de entretenimiento, lámparas, libros u otros objetos.
- Adicionalmente, nunca coloque este aparato cerca o sobre una salida de calefacción o lo instale en un lugar tal como un mueble integrado o estante para libros, a menos que la instalación proporcione una ventilación adecuada.
- Coloque este aparato sobre una superficie estable, sin vibraciones y que tenga la capacidad de aguantar su peso y tamaño.

**NOTICE FOR CUSTOMERS
IN THE UNITED KINGDOM**

CLASS II APPARATUS USING A TWO-WIRE POWER CORD

AC Mains Lead Connection (Important)

The wires in this mains lead are coloured in accordance with the following code:

Blue: Neutral

Brown: Live

As the colours of the wires in the mains lead of this apparatus may not correspond with coloured markings identifying the terminal in your apparatus, proceed as follows:

The wire which is coloured blue must be connected to the terminal which is marked with the letter N or coloured black.

The wire which is coloured brown must be connected to the terminal which is marked with the letter L or coloured red.



Warning

Do not connect the blue or brown wires to the earth terminal of a three-pin plug. Note: The earth terminal is distinguished by its color (green, or green-yellow), or by being marked with the letter E, or marked with the safety earth symbol .

NOTICE FOR CUSTOMERS IN QUEBEC



ATTENTION

**RISQUE D'ÉLECTROCUTION
NE PAS OUVRIR**



CAUTION

POUR ÉVITER TOUT RISQUE D'ÉLECTROCUTION, NE PAS RETIRER LA PROTECTION DU PRODUIT (OU LES CACHES ARRIÈRES). AUCUNE PIÈCE SITUÉE À L'INTÉRIEUR DU PRODUIT NE NÉCESSITE D'INTERVENTION DE L'UTILISATEUR, CONFIER LA RÉPARATION À DU PERSONNEL QUALIFIÉ.

ATTENTION

POUR ÉVITER TOUT RISQUE D'INCENDIE OU D'ÉLECTROCUTION, NE PAS EXPOSER CET APPAREIL À LA PLUIE OU À L'HUMIDITÉ.



CONTENTS

Safety Precautions	iii
Satellite Receiver & Satellite Antenna Grounding	v
Safety Precautions (EU Market)	vi
Mesures de Sécurité	vi
Sicherheitmassnahmen	vi
Precauciones de Seguridad	vi
Warning	vi
Attention	vi
Warnung	vi
Advertencia	vii
Caution	vii
Précautions à prendre	vii
Vorsicht	viii
Precaucion	viii
AC Mains Lead Connection (Important)	viii

Preface	xix
Document Revision History	xix
Audience	xix
Organization	xx
Conventions	xx
Related Publications	xxi

CHAPTER 1

Quick Setup	1-1
About the Video Standard	1-1
Satellite Receiver Startup	1-1
Quick Setup Instructions	1-2
Rear Panel Connections	1-3
D9865B Satellite Receiver	1-3
D9865H Satellite Receiver	1-4
D9865D Satellite Receiver	1-4

CHAPTER 2

Introduction	2-1
Overview	2-1

- Free-to-air Reception 2-1
- Secured Broadcast Reception 2-1
- Data Outputs (D9865D only) 2-1
- MIB Browser 2-2
- Key Features 2-2
 - Optional Features 2-2

CHAPTER 3

Front Panel Operation 3-1

- About the Front Panel 3-1
- Front Panel LEDs 3-2
- CI Slot 3-3
- Keyboard Display 3-3
- Setting the TV Video Format 3-3
- Common Interface Modules 3-4
- Remote Control Functions 3-4

CHAPTER 4

Setup and Monitoring via On-Screen Display 4-1

- Main Menu 4-1
 - About Using the On-Screen Menus 4-3
 - The On-Screen Buttons 4-4
 - About the Current Channel 4-4
- Channel List without EPG 4-4
- Introducing EPG 4-5
 - What is EPG? 4-5
 - Features of the EPG 4-5
 - Browsing By Channel 4-5
 - Parts of the Guide 4-6
 - Browsing by a Different Date 4-6
 - Viewing Favorites 4-6
 - Viewing Timers 4-7
 - Changing Channels 4-7
 - Setting Timers 4-7
 - Setting a Reminder Timer From EPG 4-7
 - Editing a Timer Profile 4-9
 - Deleting a Timer Profile 4-9
- Setting Up Your Favorite Channels 4-10
 - Adding a Favorite Profile 4-10
 - Editing a Favorite Profile 4-11
 - Deleting a Favorite Profile 4-12

Performing a Channel Scan	4-12
Setting Up One Button Channel Change	4-12
Setup Menu	4-14
Setting up Tuning / Preset	4-15
Setting up the Preset / LNB	4-17
Selecting the Active Preset	4-18
Editing Network Presets	4-19
Setting up LNB	4-19
Setting Up the Satellite Dish	4-21
Adjusting the Satellite Position in Installer Mode	4-25
Changing the Satellite Position in User Mode	4-25
Adjusting the Satellite position using Signal Tones	4-25
Signal Level and Signal Quality	4-26
Signal Lock	4-26
Setting up the Video	4-26
Actual Conversion Table	4-28
Video Output Restrictions	4-31
Setting up Subtitles	4-32
Setting up Audio	4-33
Digital Audio Preference Settings	4-34
Viewing Advanced Settings	4-35
Setting up Advanced User Settings	4-36
Changing the Lock Level	4-38
Performing a Factory Reset	4-39
Rebooting the Receiver	4-39
Resetting the Web GUI Login Information	4-40
Setting up POV Mode	4-40
Viewing the Network Setup Menu (D9865D only)	4-41
Configuring IP Setup	4-42
Setting the Unicast IP Address	4-45
Setting the Multicast IP Address	4-47
Setting up SNMP	4-48
Configuring Noise Cutoffs	4-50
Setting up Alarms and Warnings	4-53
Performing Over-the-Air Downloads	4-55
Setting Bootable Application Selection	4-56
Viewing System Information	4-57
Viewing the Version Information	4-58
Viewing Hardware Information	4-58
Viewing Service Information	4-59

- Viewing Channel Information 4-60
- Viewing DVB-CI Information 4-62
- Viewing Device Status Information 4-63
- Viewing the Active Alarm and Warning Messages 4-63
- Viewing the RF Status 4-65
- Viewing ADP Status 4-67

CHAPTER 5

- Setup and Monitoring via Web GUI 5-1**
 - Logging on to the Web GUI 5-2
 - Overview of the Main D9865 Settings 5-3
 - Linked Pages 5-5
 - D9865 Web GUI Environment 5-6
 - The Window Buttons 5-6
 - The About Window 5-7
 - Setting up Tuning Information 5-8
 - Setting Up Dish Pointing 5-10
 - To set up the dish in Installer Action mode: 5-11
 - Setting up SI Receive Parameters 5-13
 - Setting up Muting Threshold Controls 5-15
 - Setting up the Tuning Presets/LNB 5-17
 - Setting up LNB Presets 5-18
 - Viewing Input Status 5-19
 - Setting the Channel Information 5-20
 - Configuring the Common Interface (CI) Information 5-21
 - Viewing the PSI Tables 5-24
 - Viewing PSI Frequency Information 5-25
 - Viewing the PSI Channels 5-27
 - Setting up the Video 5-28
 - Configuring Captions 5-29
 - Setting up Subtitles 5-30
 - Setting up Audio 5-32
 - Viewing System Information 5-33
 - Viewing Features/Licenses 5-34
 - Setting Up IP Information 5-35
 - To Configure Management and Data Port Settings 5-35
 - Setting Up IP Routing 5-36
 - Setting Up SNMP and Trap Destinations 5-37
 - Configuring Time/Clock Information 5-38

Configuring Favorites and Reminders	5-39
To Edit a Favorites Profile	5-40
Viewing the Alarm/Warning Status	5-41
Setting Up Alarms and Warnings	5-42
To Set Up Alarms	5-42
To Set up Warnings	5-43
Viewing the Alarm/Warning History	5-44
Viewing Version Information	5-45
To Change the Download Application	5-45
Viewing Hardware Information	5-46
Setting Up Import/Export Information	5-46
Viewing the Backup/Restore History	5-47
Managing D9865 Web GUI Accounts	5-48
To Configure the User Login Passwords	5-48
To Add a User Account	5-49
To delete a user account	5-50
Configuring Lock Level Settings	5-51
Changing the Lock Level Password	5-52
Viewing Contact Information	5-53
Viewing Diagnostic Logs	5-53
Viewing the Usage Counters	5-54
Performing Service Actions	5-55
To Load a Software Version	5-55
To Change the Download Application	5-55

CHAPTER 6**Service and Maintenance 6-1**

Alarm Messages	6-1
Warning Messages	6-10
Troubleshooting	6-13

APPENDIX A**Technical Specifications A-1**

Receiver Specifications	A-1
General	A-1
Tuner	A-2
LNB Requirements	A-2
DVB-S and DVB-S2	A-2
DVB-S Eb/No (C/N) Ratio	A-3

- DVB-S2 Error Rate Performance ES/No (C/N) Ratio **A-3**
- Video Output **A-4**
 - Analog Video Output **A-4**
 - Digital Audio/Video Output (D9865H and D9865D only) **A-4**
 - HD Analog Video Output (D9865H and D9865D only) **A-4**
- Audio Outputs **A-5**
 - Analog Audio Output **A-5**
 - Digital Audio S/PDIF Output **A-5**
 - VBI **A-5**
- Power **A-5**
 - AC Power Connector **A-5**
- General **A-6**
 - Mechanics **A-6**
 - Environment **A-6**

APPENDIX B

Default Settings B-1

- Factory Default Settings **B-1**
 - Tuning/Preset **B-1**
 - Preset - Number 1 **B-2**
 - Preset Number 2 **B-2**
 - Preset - Number 3 **B-2**
 - Preset - Number 4 **B-3**
 - Preset - Number 5 **B-3**
 - Preset - Number 6 **B-3**
 - Preset - Number 7 **B-4**
 - Preset - Number 8 **B-4**
 - Preset - Number 9 to 63 **B-4**
 - Preset - Number 64 **B-5**
 - LNB Setup - Configuration 1 to 9 **B-5**
 - LNB Setup - Configuration 10 **B-5**
 - Video Setup **B-6**
 - Subtitle Setup **B-6**
 - Audio Setup **B-6**
 - Administration **B-7**
 - POV Mode **B-7**
 - Advanced Administration **B-7**
 - IP Setup **B-7**
 - Unicast IP Setup **B-8**
 - Multicast IP Setup **B-8**

Trap Destination Setup	B-8
SNMP	B-8
Noise Cutoffs	B-8
Download	B-9
CI Setup (Web GUI only)	B-9
Import/Export (Web GUI only)	B-9
Alarms and Warnings	B-9

APPENDIX C**Lock Levels C-1**

D9865 Satellite Receiver Lock Levels	C-1
Video	C-1
All Screens	C-2
Channel List	C-2
EPG Grid	C-3
EPG Info	C-3
NAVigator Info	C-3
Timers	C-3
Favorites	C-4
Edit Favorites	C-4
Timers	C-4
One Button Channel Change (button presses)	C-4
Tuning/Preset	C-5
Tuning/Preset:Preset	C-5
Tuning/Preset:Preset:LNB	C-5
Dish Setup (User Mode)	C-5
Dish Setup (Installer Mode)	C-5
Video Setup	C-6
Subtitles	C-6
Audio Setup	C-6
Administration	C-7
Advanced Administration	C-7
POV Mode	C-7
IP Setup	C-8
Change IP Address	C-8
Unicast/Multicast IP Setup	C-8
SNMP Setup	C-8
Trap Destinations	C-9
Noise Cutoffs	C-9
Alarms and Warnings	C-9
Alarm/Warning Setup	C-9

[Download](#) **C-9**
[Bootable App Selection \(Screen\)](#) **C-9**
[Info](#) **C-10**

APPENDIX D **Declaration of Conformity** **D-1**

INDEX



Preface

This guide describes the audience, use and organization of the Cisco D9865 Satellite Receiver Software Version 2.15 Installation and Configuration Guide. The preface also outlines the document conventions and support information.

This preface contains the following sections:

- [Document Revision History, page xix](#)
- [Audience, page xix](#)
- [Organization, page xx](#)
- [Conventions, page xx](#)
- [Related Publications, page xxi](#)

Document Revision History

The following table describes information that has been added or changed since this guide was first published.

Document Version	Date	Notes
47-4035197-01 Rev D	October 2012	Modified the software download information.
4035197 Rev C	October 2010	Included operational changes.
4035197 Rev B	January 2010	Added new features, as per R2 and removed end user agreement.
4035197 Rev A	November 2009	Initial release.

Audience

The audience of this manual includes users (operators) and service personnel who are responsible for the installation, configuration, operation, monitoring and service of the D9865 Satellite Receiver.

To use this documentation, the user should have a basic knowledge of the technology used in relation to this product. Service personnel should have additional skills and be familiar with cabling, electronic circuitry, and wiring practices.

This manual is intended for operators who are responsible for the configuration, remote operation and maintenance of the D9865 receiver.

Organization

This guide includes the following chapters and appendices:

Chapter or Appendix	Description
Chapter 1, “Quick Setup”	Provides information about initially configuring the D9865 Satellite Receiver and an overview of the rear panel connections.
Chapter 2, “Introduction”	Provides a brief introduction to the D9865 Satellite Receiver.
Chapter 3, “Front Panel Operation”	Provides an overview of the front panel and remote control functions.
Chapter 4, “Setup and Monitoring via On-Screen Display”	Provides on-screen set up and monitoring details for the D9865 Satellite Receiver.
Chapter 5, “Setup and Monitoring via Web GUI”	Provides details on setting up and monitoring the D9865 Satellite Receiver through the web GUI.
Chapter 6, “Service and Maintenance”	Provides additional information on all the alarms and warnings in the D9865 Satellite Receiver.
Appendix A, “Technical Specifications”	Provides the technical specifications of the D9865 Satellite Receiver.
Appendix B, “Default Settings”	Provides a list of all the default settings.
Appendix C, “Lock Levels”	Provides a list of lock levels for the D9865 Satellite Receiver.
Appendix D, “Declaration of Conformity”	Provides the declaration of conformity for the D9865 Satellite Receiver.

Conventions

This document uses the following conventions:

Convention	Indication
bold font	Commands and keywords and user-entered text appear in bold font .
<i>italic font</i>	Document titles, new or emphasized terms, and arguments for which you supply values are in <i>italic font</i> .
[]	Elements in square brackets are optional.
{ x y z }	Required alternative keywords are grouped in braces and separated by vertical bars.
[x y z]	Optional alternative keywords are grouped in brackets and separated by vertical bars.
string	A nonquoted set of characters. Do not use quotation marks around the string or the string will include the quotation marks.

<code>courier font</code>	Terminal sessions and information the system displays appear in <code>courier font</code> .
< >	Nonprinting characters such as passwords are in angle brackets.
[]	Default responses to system prompts are in square brackets.
!, #	An exclamation point (!) or a pound sign (#) at the beginning of a line of code indicates a comment line.

**Note**

Means *reader take note*.

**Tip**

Means *the following information will help you solve a problem*.

**Caution**

Means *reader be careful*. In this situation, you might perform an action that could result in equipment damage or loss of data.

**Warning**

Means *reader be warned*. In this situation, you might perform an action that could result in bodily injury.

Related Publications

These documents provide more information on the D9865 Satellite Receiver and are available from the Cisco.com site:

- Cisco D9865 Satellite Receiver Release Version 2.15 Release Note
- Open Source Used In Cisco D9865 Satellite Receiver Software Version 2.15



CHAPTER 1

Quick Setup

This chapter provides a quick setup of your D9865 Satellite Receiver. If you are unsure about which receiver settings to use, contact your local service provider for assistance. This chapter presents the following major topics:

- [About the Video Standard, page 1-1](#)
- [Quick Setup Instructions, page 1-2](#)
- [Rear Panel Connections, page 1-3](#)

About the Video Standard

The Video Standard used to operate the receiver is preset at the factory to either NTSC (525-line), or PAL (625-line). Changing the Video Standard is normally required only when operating the receiver in a network or jurisdiction that uses the alternate Video Standard, and/or when new (or different) subscriber services are made available. Changing the Video Standard or resetting the receiver to the default factory settings may cause TV video to display improperly.

Satellite Receiver Startup

-
- Step 1** Check your installation:
- Check that your receiver is correctly installed and connected to the satellite LNB antenna, to other A/V equipment (as required) and to AC power.



- Note** This product plugs into a socket outlet. A socket outlet must be near this product, and must be easily accessible.
- The product has a power switch (located on the rear panel). It may be used to turn off the receiver to conserve energy.
-

- Step 2** The application code version and APP appears on the receiver front panel while it is powering up. It takes about 60 seconds for the receiver to completely power up. Once the receiver has completely powered up, a flashing “.” appears on the front panel.
- Step 3** Turning on the receiver: Press the **DISPLAY** button on the Remote Control or press the **DISPLAY** button on the receiver front panel.

- Step 4** A “No signal” message is displayed on the TV monitor. To set up your receiver for your network to receive your authorized programs, refer to [Quick Setup Instructions, page 1-2](#).

Quick Setup Instructions

The following instructions are for use with the Remote Control.

-
- Step 1** Display the **MAIN MENU** by pressing **MENU**.
- Step 2** Press the **▼** button to move to the **Setup Menu** and press **OK**.
- Step 3** Move to the **Tuning / Preset** menu and press **OK**.
- Step 4** Enter or select the following parameters on this menu from your service provider. Refer to [About the Front Panel, page 3-1](#) for instructions on the use of the arrow buttons.
- Enter the **Modulation Type** (DVB-S, DVB-S2).
 - Enter the **Downlink Frequency** (in GHz).
 - Enter the **Symbol Rate** (in MS/s).
 - Enter the **NetId**.
 - Select **LO Select** (On, Off, Auto) when using a Ku-band dual LNB. This controls the 22 kHz tone.
 - Enter **LO Freq 1** (in GHz) based on C or Ku-Band LNB operation (e.g., 9.75 for Ku-Band, 5.150 for C-Band).
 - Enter **LO Freq 2** (in GHz). Use this when using a Ku-band dual LNB. LO Freq 2 > LO Freq 1.
 - Enter the **Crossover** frequency when using a Ku-band dual LNB.
 - Enter the **LNB Power**. Turn on if using the receiver to power the LNB.
 - Select **DiSEqC** (if required). This allows control of the satellite dish motor.



Note LNB Power must be on to use DiSEqC functions.

- Select the LNB port for the **DiSEqC Switch** (if used).



Note The LNB power alarm will be on if LNB power is on for use with a DiSEqC switch, but external power is also used.

Receivers with Factory Pre-configured Presets

If the receiver has been factory pre-configured with presets, press the yellow button to go to the **Preset / LNB Setup** menu to view the presets and select the one for your network.



Note You need to press **OK** to view the parameters and **Name** of the preset.

Once you have selected your network preset by scrolling through the presets in the **Preset** field, press the blue button to **Activate** the displayed preset as the current preset.

Go to Step 5.

Step 5 The “Acquiring Network” message is displayed until the “Acquisition Status” message appears. Press **OK** to continue or press **EXIT** to cancel and return to the menu. If the dish is aligned, Signal Lock will display “Lock” to the right.

Press **EXIT** to go to video.

If the dish is not aligned, the “Acquisition Failed” message is displayed. Select **OK** to save the settings. Go to the **Dish Setup** menu to align the dish.

Rear Panel Connections

D9865B Satellite Receiver

The following displays the rear panel of the D9865B Satellite Receiver:

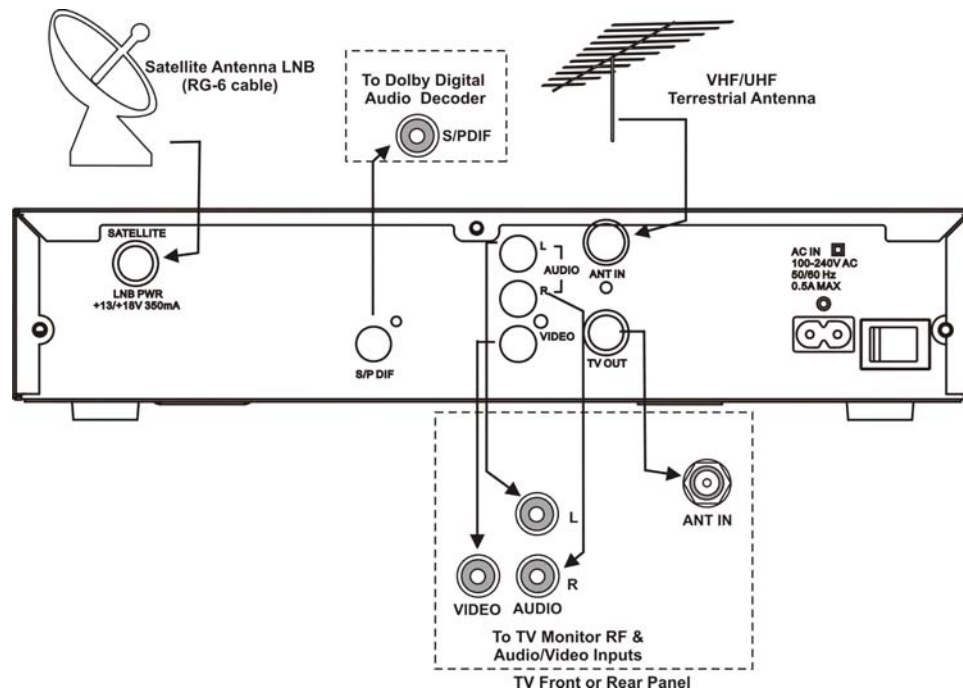

D9865H Satellite Receiver

The following displays the rear panel of the D9865H Satellite Receiver:

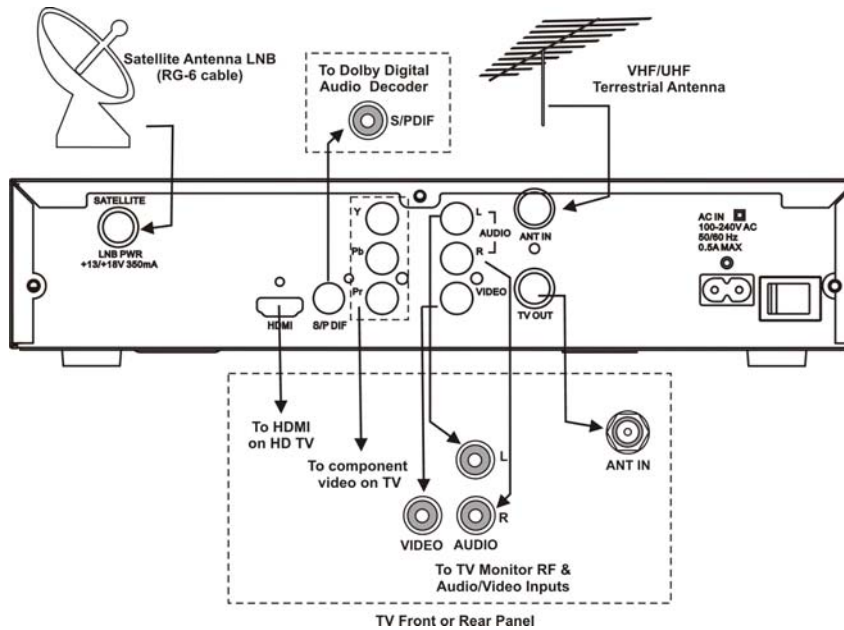

D9865D Satellite Receiver

The following displays the rear panel of the D9865D Satellite Receiver.



Note

Only ETH1 Ethernet port is currently available.

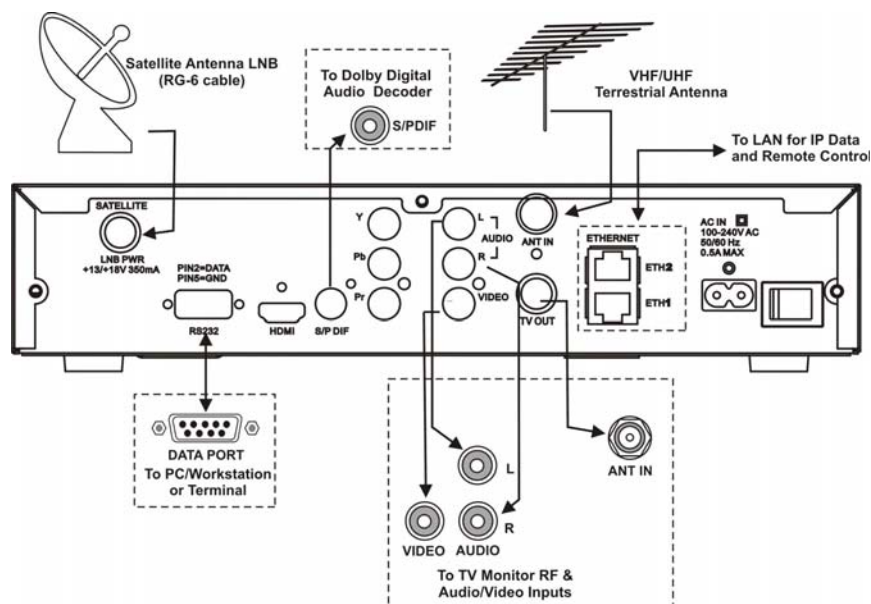



CHAPTER 2

Introduction

This chapter is a general introduction to the Cisco® D9865 Satellite Receiver. It describes the most common applications and interfaces of the receiver. This chapter presents the following major topics:

- [Overview, page 2-1](#)

Overview

The Cisco D9865 Satellite Receiver is designed for satellite content distribution and it targets the broadcast, business TV, private networks, and SMATV environment. The receiver offers the ability to receive digitally encrypted video, audio, VBI, and data. It provides a cost-effective, variable-rate solution to transition existing DVB-S/MPEG-2 services to DVB-S2/MPEG-4. Additional features include IP data and RS-232 utility data (D9865D only).

The unit is set up via the on-screen display menu, using a handheld infrared remote control, or navigation keys on the front panel of the receiver. The unit can also be set up and monitored using the embedded Web interface (D9865D only). User-editable presets are provided for quick re-tuning to other broadcasts. The receiver also supports SNMP control via the Ethernet port as an option (D9865D only).

Free-to-air Reception

This receiver is capable of receiving a DVB/MPEG compliant free-to-air broadcast.

Secured Broadcast Reception

Supporting the PowerVu conditional access with DES or DVB descrambling, or with DVB Conditional Access Module (CAM) based DVB CA systems, this receiver can be used to receive secured corporate communication of video, audio, and data broadcast. It can also be used for secured delivery of TV programming to hotels, MDUs, homes, and commercial establishments such as restaurants and stores.

Data Outputs (D9865D only)

Data outputs can be used for distribution of electronic documents, such as price lists and video files. Utility data (RS-232) can be used for smaller file transfer at a slower speed. DVB MPE IP data via an Ethernet interface allows for connection to a local area network for larger file transfer or communication with multiple network clients.

MIB Browser

A MIB Browser is a type of SNMP manager, which can be used to communicate with SNMP agents. It is a tool for reading and writing to controls and status objects defined by the MIB. A MIB file is included in the delivery from Cisco for the D9865 Satellite Receiver to support third party SNMP managers.

Key Features

The D9865 receiver provides the following key features:

- DVB-S QPSK, DVB-S2 QPSK/8PSK demodulation
- Variable QPSK symbol rates from 1 to 45 MS/s for DVB-S and 1 to 31 MS/s for DVB-S2
- PowerVu® conditional access with DES and DVB descrambling
- CAM interface hardware for DVB CAM-based descrambling
- 4:2:0 High Definition (HD) MPEG-2 and MPEG-4 AVC decoding
- 4:2:0 Standard Definition (SD) MPEG-2 and MPEG-4 AVC decoding
- 4:2:0 NTSC and PAL (B/G/I/D/M/N) video decoding
- MPEG, Dolby® Digital Plus and HE-AAC audio decoding
- DVB Subtitling and DVB VBI (WST, WSS, VPS)
- One unbalanced stereo pair of audio outputs
- Line 21 closed caption and V-chip support
- Fingerprint trigger
- Service replacement
- Field upgradeable software and security
- Front panel 4-digit LED for channel display
- On-screen display menu for setup and status
- User-editable preset configurations

Optional Features

The following features are available options:

- HDMI and component video outputs for HDTV (D9865H and D9865D only)
- Support HDCP on HDMI port (D9865H and D9865D only)
- Dual Ethernet 10/100BaseT for IP data and SNMP control (D9865D only)
- Multiprotocol Encapsulation (MPE) data support with static Unicast routes and Multicast forwarding (D9865D only)
- Low Speed Data (D9865D only)
- SNMP traps support for alarms and warnings (D9865D only)
- MIB Browser support, used to manage SNMP requests (D9865D only)
- Web browser interface for easy setup, control, and monitoring (D9865D only)
- Browse channels using the Electronic Program Guide (EPG) (manufacturing option only)



CHAPTER 3

Front Panel Operation

This chapter describes how to set up the D9865 Satellite Receiver using the front panel keys and display. This information is primarily applicable for standalone operation. This chapter presents the following major topics:

- [About the Front Panel, page 3-1](#)
- [Common Interface Modules, page 3-4](#)
- [Remote Control Functions, page 3-4](#)

About the Front Panel

The front panel of your satellite receiver provides controls for enabling the receiver's video output, and for interfacing with the remote control. MUTE, SIGNAL and MENU LEDs are also provided. Some remote control buttons are duplicated on the front panel for activating and navigating menus.



The following table displays a description of the front panel buttons:

Button	Function
DISPLAY	Enables the video display output. When the video display is enabled, the channel number is displayed on the front panel. When switched off, a “.” flashes.
MENU	Enters Menu mode or returns to video. Returns to previous menu.
SELECT	Selects menus. Enters or exits edit mode.
◀▼▲▶	In Menu mode, used to navigate menus.
◀▶	In Video mode, used for volume up/down.
▲▼	In Video mode, used for channel up/down.

To change a setting on a menu using the front panel:

-
- Step 1** Use the ◀▼▲▶ buttons to move to the setting you want to change. Press the **Select** button to select the setting.
- Step 2** For numeric options, you can:
- use the ◀▼▲▶ buttons to change the value one digit at a time, or
 - navigate to Keyboard using the ◀▼▲▶ buttons to use an on-screen keyboard.
- Step 3** To access the menus at the bottom of the screen (for example, Save), navigate to the appropriate selection using the ◀▼▲▶ buttons and press **Select**. A help message is displayed at the bottom of the screen.
- Step 4** Press **Menu** to move to the previous menu.
-

Front Panel LEDs

The functions of the LEDs are described in the table below:

LED	Function
MUTE	On when sound is muted.
SIGNAL	On when receiver is synchronized with the incoming digital signal and authorized for the current channel. Flashing when a signal has been found, but receiver is not authorized for the current channel. Off when no signal has been found. For more information about troubleshooting your satellite receiver, see Troubleshooting, page 6-13
MENU	On when on-screen menus are displayed.

CI Slot

The CI Slot allows the use of CAM (Conditional Access Module) Smart Card to decrypt purchased programming. For setup information, see [Viewing DVB-CI Information, page 4-62](#) and [Configuring the Common Interface \(CI\) Information, page 5-21](#). For a list of supported CAMs, refer to [Common Interface Modules, page 3-4](#).

Keyboard Display

Press the **MENU** and **SELECT** buttons simultaneously on the Front Panel to display a keyboard on the TV monitor. The keyboard allows alphabetical and numerical character entry in menu fields using the front panel. Alternatively, press the red button on the remote control.

You must have a menu field selected (i.e., must be in edit mode) to display the keyboard.

1. Use the arrow buttons to move along the keyboard.
2. Press **OK** to select a number or letter for each entry.

Setting the TV Video Format

The video format is set to the standard format for your country. Check with your satellite or local service provider before changing this setting to ensure it is set correctly. If you are instructed to change this setting for your TV set:

-
- Step 1** Press the **SELECT** and **▲** buttons on the receiver front panel at the same time.
- Step 2** Press **SELECT** and **▲** again. The video format is displayed on the receiver front panel (e.g., NTSC, PAL, etc).
- Step 3** Press **▲** until you display your video format. Each change is viewable on-screen.
- Step 4** Press **SELECT** to save the setting and re-display the selected channel.



Note You must be in video mode (i.e., on-screen menus not displayed) to perform this function on the receiver front panel.



Note This function is not available through the remote control.

Common Interface Modules

The following lists the supported CAMs:

Common Interface Modules	Part Number
Aston Professional CAM, for descrambling CONAX	4016669
Aston Consumer CAM for descrambling CONAX	4016670
CAM for descrambling CryptoWorks	V9523361
Aston Professional CAM for descrambling Irdeto	4016671
Aston Consumer CAM for descrambling Irdeto	4016672
Aston Professional CAM for descrambling MediaGuard	V9528197
Aston Consumer CAM for descrambling MediaGuard	V9528198
Aston Professional CAM for descrambling Viaccess	V9528199
Aston Consumer CAM for descrambling Viaccess	V9528240













Remote Control Functions

The remote control is provided as a standard feature with the D9865 Satellite Receiver. After unpacking your satellite receiver, check that you have the following accessories (if ordered):

- One IR (Infra-Red) Remote Control transmitter (RCU)
- Two AAA size batteries for Remote control (not included for Argentina)

The Remote Control is used to control receiver functions. You can switch the video/audio outputs on and off plus activate and navigate the on-screen menus. Some remote control functions are duplicated on the front panel (see [Front Panel LEDs](#), page 3-2).

Remote Control	Button	Function
	DISPLAY	Enables the video/audio outputs.
	0 to 9	<p>Enters channel numbers or information on on-screen menus.</p> <p>Alphanumeric character entry for “Name” field on the on-screen menus (similar to keys on telephone keypad). If an entered value is out of range or conflicts with another setting, a pop-up message displays information about the error.</p> <p>00 (pressing 0 twice) – deletes a character at the cursor location.</p> <p>11 (pressing 1 twice) – adds a space at the cursor location.</p>
	FAV	Displays Favorite screen where you can view and set favorite channels.
	LAST	Displays last channel.
	MENU	<p>Displays Main Menu.</p> <p>Exits edit mode in menus.</p> <p>Returns to video in video mode.</p> <p>Returns to previous menu.</p>
	EPG	If the receiver is enabled to receive EPG (Electronic Program Guide) data, an interactive EPG guide will be displayed when pressed. If not, a channel list menu and video will be displayed.

Remote Control	Button	Function
	 	In Video mode, used to select channels. In Menu mode, used to move through on-screen menus.
	 	In Video mode, increases or decreases volume. In Menu mode, used to move through on-screen menus.
		Selects menus (functions same as SELECT button on front panel). Enters or exits edit mode.
	CH+, CH-	Channel up/down.
	VOL+, VOL-	Volume up/down.
	EXIT	Exits from edit mode. Exits menus (returns to video).
		Mutes sound.
		Changes to uppercase letter mode. Page up when scrolling the on-screen menus.
		Changes to lowercase letter mode. Page down when scrolling the on-screen menus.
		Red – different on each menu. Also displays the soft keyboard.
		Green – different on each menu
		Yellow – different on each menu
		Blue – different on each menu
	Setup	Displays the Setup Menu.



CHAPTER 4

Setup and Monitoring via On-Screen Display

This chapter describes how to set up and monitor the D9865 Satellite Receiver using the on-screen display. This information is primarily applicable for standalone operation. This chapter presents the following major topics:

- [Main Menu, page 4-1](#)
- [Channel List without EPG, page 4-4](#)
- [Introducing EPG, page 4-5](#)
- [Setting Up Your Favorite Channels, page 4-10](#)
- [Setting Up One Button Channel Change, page 4-12](#)
- [Setup Menu, page 4-14](#)

Main Menu

This section contains the information you need to set up your Satellite Receiver using the on-screen display menus. Before you begin using the receiver, you may need to change the current settings to suit your operating requirements.

To display the Main Menu, press the **MENU** button on the remote control or receiver front panel.

If the D9865 Satellite Receiver is enabled to receive Electronic Program Guide (EPG) data, the following Main Menu screen appears:

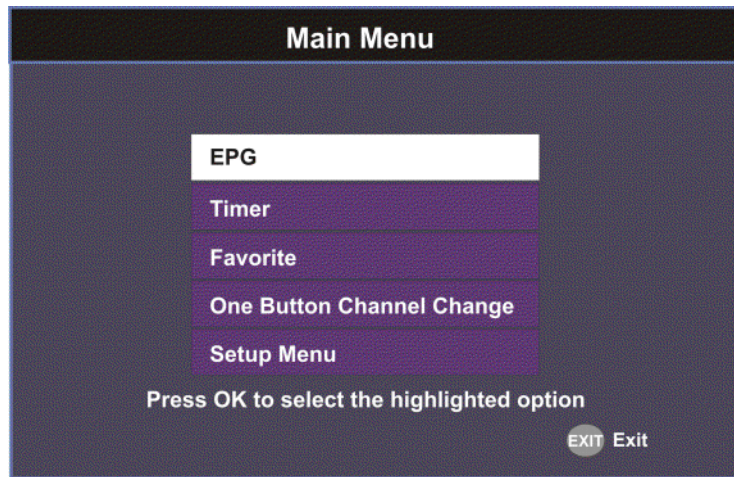

As shown above, you can select the EPG, Timer, Favorite, One Button Channel Change, or the Setup Menu.

- EPG - displays an interactive EPG guide with all the available subscriber channels.
- Timer - Displays reminder timers set for upcoming programs.
- Favorite - Displays a list of favorite channels set by the user.
- One Button Channel Change - Ability to assign a channel to each of the colored buttons at the bottom of the remote control.
- Setup Menu - provides access to menus to set up tuning, select and set up presets, set up video, audio, and other advanced parameters, in addition to viewing the receiver operating status.

If the receiver does not support EPG, the following Main Menu screen appears:

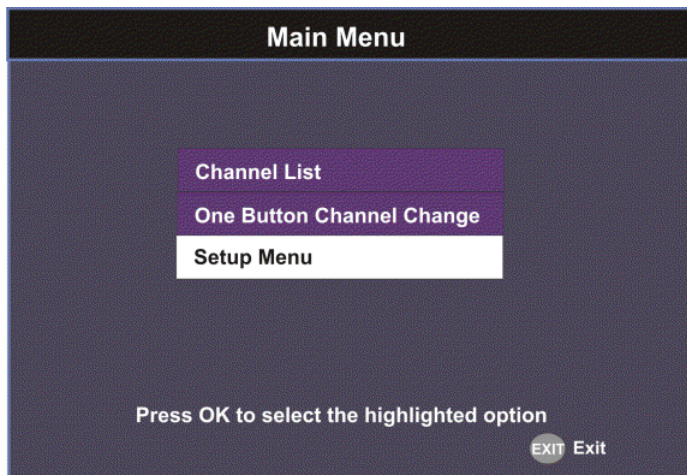

As shown above, you can select the **Channel List**, **One Button Channel Change**, or the **Setup Menu**.

- Channel List – displays all the available subscriber channels. See an example of a Channel List below.

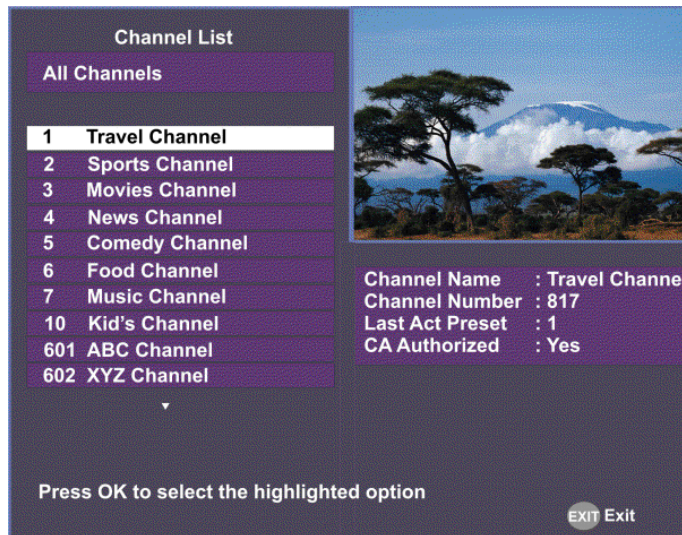

- One Button Channel Change - provides ability to assign a channel to each of the colored buttons at the bottom of the remote control.
- Setup Menu - provides access to menus to set up tuning, select and set up presets, set up video, audio, and other advanced parameters, in addition to viewing the receiver operating status.

About Using the On-Screen Menus

All screens or menus are accessed from the Main Menu. While viewing any channel, you can display on-screen menus for viewing or changing the current receiver setup. While in menus, you can change the current receiver settings, and/or display other menus. Some menus contain status information, which is available for viewing only and cannot be changed.

To change a setting on a menu using the remote control:

1. Use the ◀▼▲▶ buttons to move to the setting you want to change.
2. Press the **OK** button to select the setting.
3. For numeric options, you can use one of the following methods:
 - enter the number directly using the numeric keypad on the remote control,
 - use the ◀▼▲▶ buttons to change the value one digit at a time, or
 - press the red button (keyboard) to use an on-screen keyboard.
4. Press **OK** to save the setting and exit the menu. A help message is displayed at the bottom of the screen.
5. Press **MENU** to move to the previous menu.



Note The steps in this chapter are based on using the remote control. For more information on changing a setting on a menu using the front panel controls, see [About the Front Panel, page 3-1](#).

The On-Screen Buttons

The on-screen menus have the following common buttons:

Button	Description
Save	Saves and applies the settings to the receiver.
Exit	Exits edit mode and menu. A message prompts you to save or discard changes before you exit the menu.

About the Current Channel

When you navigate to menus from a video channel, the information displayed is associated with the current (video) channel. If no changes have been made to the current setup, you are automatically returned to the same video channel when you exit to video.

Channel List without EPG

If the receiver does not support EPG, you can access the Channel List from the Main Menu.

To select a channel from the channel list:

- Step 1** From the **Main Menu** screen, select **Channel List** and press **OK**. The Channel List displays all the available subscriber channels.

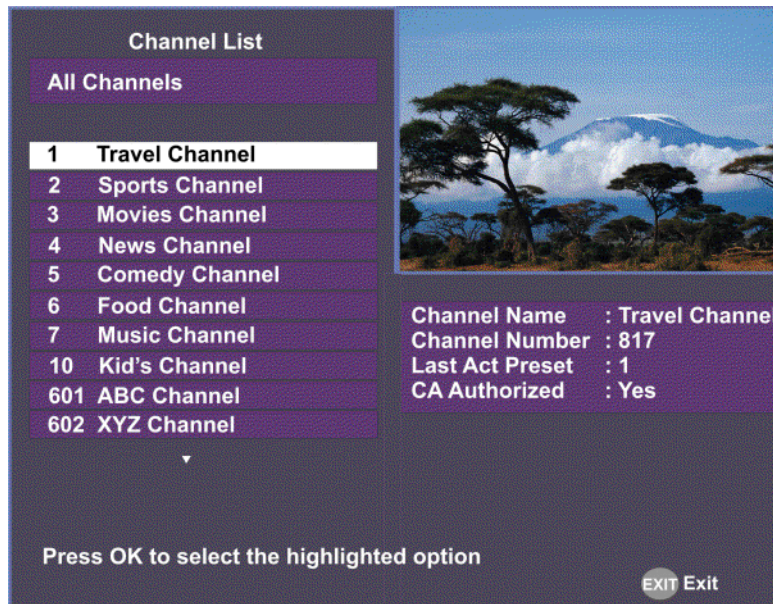

- Step 2** Select a channel from the channel list and press **OK**. This will tune to the selected channel (top right) and the channel information is displayed in the bottom right of the channel list.

Options	Description
Channel Name	Name of the current channel.
Channel Number	Current channel number.
Last Act Preset	Indicates the number of the last activated preset.
CA Authorized	Indicates whether the receiver is authorized to receive the signal.

Step 3 The channel list screen will close when you press **OK**.

Introducing EPG

What is EPG?

The Electronic Program Guide (EPG) is a convenient way to find out what is on your TV and to view a list of upcoming programs. Lists of programs are available for any date in the next 7 days depending on the network provider.

Features of the EPG

The following list provides an overview of the features of an EPG:

- With the browsing features, you can see what is on TV for a particular channel, program channel, or program title.
- Instant program descriptions appear while using the browsing feature to view detailed channel information.
- Timers help you keep track of upcoming programs by providing reminders on the screen before the program starts.
- You can set up Favorite profiles for a quick browse of your favorite channels.

Browsing By Channel

From the Main Menu, select EPG and press **OK**. The EPG main screen is shown below. The EPG screen enables you to browse by channel, which lists all the available programs in order by time of day and date.

Parts of the Guide

The following list describes the parts of the guide.

- The program you are watching is reduced to fit in the upper right are of your screen. The program remains there while you are using the main functions of the guide.
- The current Information banner under the picture provides the current date, time and channel.
- The Channel Banner provides a description for each program you highlight in the main program list.
- The Main Program listing displays the programs that will be broadcast.
- Press the blue button (**Timers**) to view the list of timers set for upcoming programs.
- Press the red button (**Favorite**) to view the list of Favorite profiles.

Browsing by a Different Date

You can view upcoming program information for up to 7 days in advance by changing the day of the week you are browsing.

Press the yellow button (**Next Day**) or the green button (**Prev Day**) to change the day of the week to view upcoming program information on the following day. Press the green button (**Prev Day**) to view the program information.

Viewing Favorites

Press the red button (**Favorite**) to view a list of all the configured Favorite profiles.

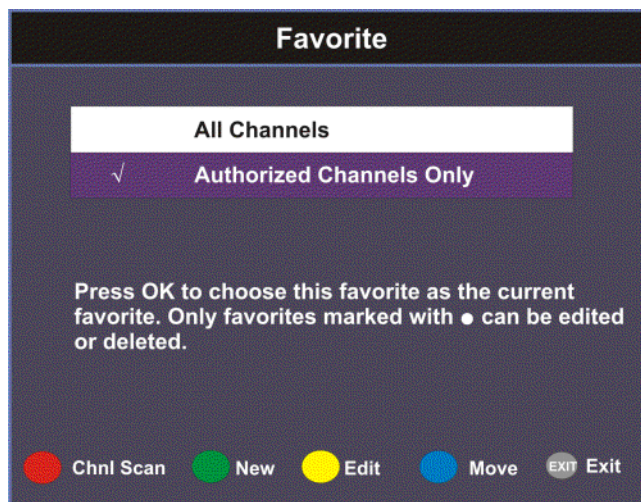

For more information on setting up the favorite profiles, see [Setting Up Your Favorite Channels](#), page 4-10.

Viewing Timers

Press the blue button (**Timers**) to view all the configured timer profiles.

For more information on setting up and maintaining timer profiles, see [Setting Timers, page 4-7](#).

Changing Channels

As you change the channel while watching TV, a brief channel banner appears along the bottom of the TV screen with the current time and channel information. For program details, press the green button (**Info**). The Extended Info screen is displayed, with additional program information. The following displays an example of a channel banner:

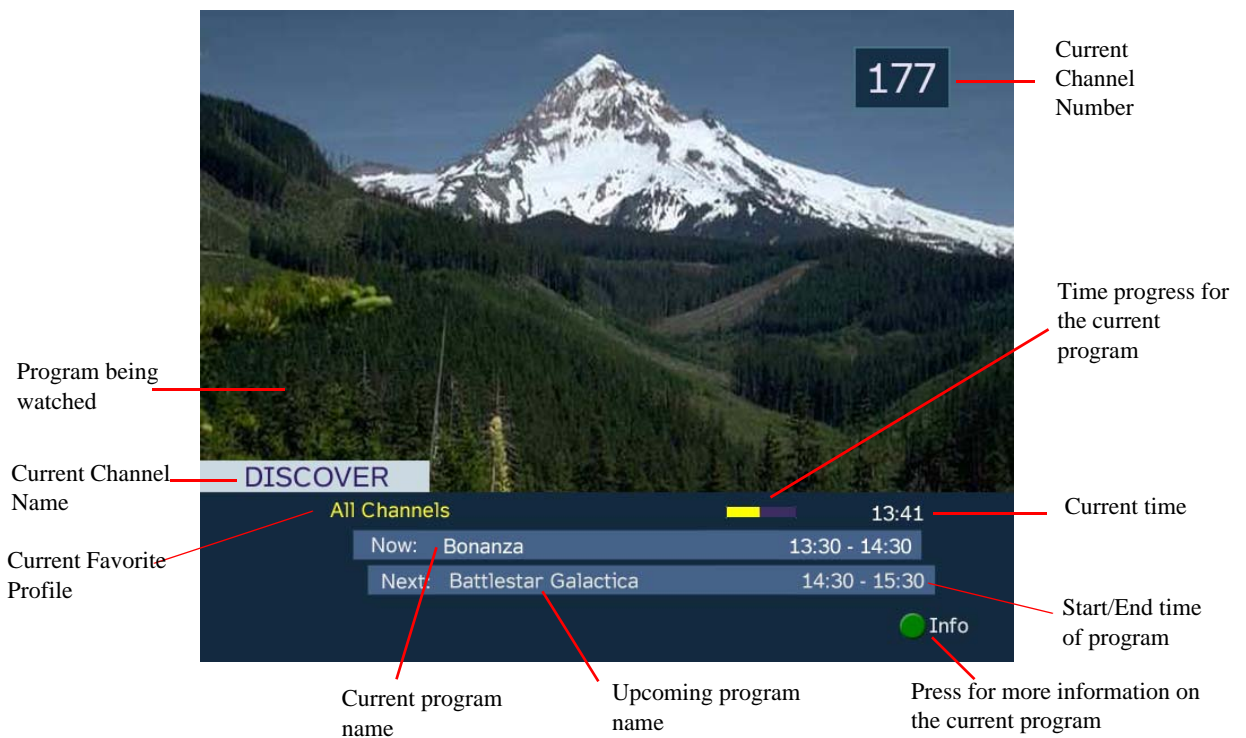

Setting Timers

Setting a Reminder Timer From EPG

You can set up timers that will display a reminder on-screen when the configured program is on.



Note

You cannot set a timer for a program that has already started.

Proceed as follows to set a reminder timer from EPG:

Step 1 From the Main Menu screen, select **EPG** and press **OK**.

- Step 2** Select an upcoming program you want to set a reminder by scrolling through the guide using the ◀▶ buttons and then press **OK**. The Extended Info screen is displayed with the channel name, information and program time.

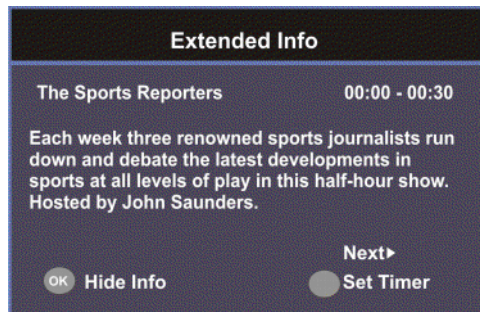

- Step 3** If the program selected has already started, press **Next ▶** to set a timer for the next time slot.

- Step 4** Press the green button (**Set Timer**). The Set Timer screen is displayed.

The following table describes the channel information and the timer options:

Channel/Timer Information	Description
Channel Number	Number of the selected channel.
Channel Name	Name of the selected channel.
Event Name	Name of the selected program.
Day	Day of the week the program will be on the selected channel.
Start Time	Start time of the selected program.
Frequency	Set the frequency of the reminder: Once, Daily, Weekly, or Weekdays.

- Step 5** Click the green button (**Save**) to save your timer settings.



Note You can set a maximum of 50 timer profiles.

The following is an example of a reminder that appears on-screen:



Press **OK** to close the reminder window and tune to the specified channel. Otherwise, press **Exit** to close the reminder window.

The clock symbol on the left hand side displays a countdown of seconds left before the program starts and the reminder window closes.

Editing a Timer Profile

Step 1 From the Main Menu, select **Timers** and press **OK**. The Timers screen is displayed.

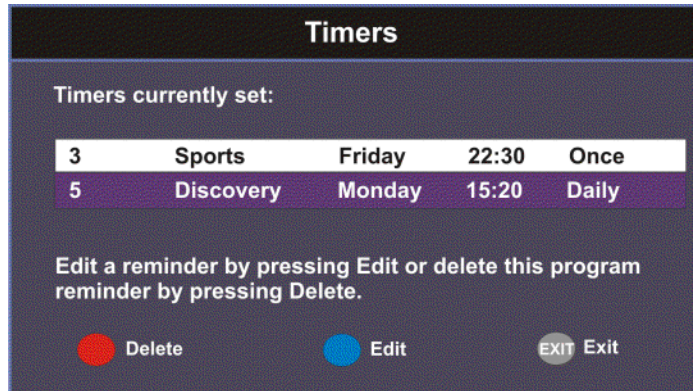

Step 2 From the Timers screen, scroll to the Timer profile you want to edit using the ▼▲ buttons.

Step 3 Select **Edit** or press the blue button (**Edit**). The Set Timer screen is displayed.

Step 4 Make the necessary changes.

Step 5 Press the green button (**Save**) to save the Timers list.

Deleting a Timer Profile

Step 1 From the Main Menu, select **Timers** and press **OK**. The Timers screen is displayed.

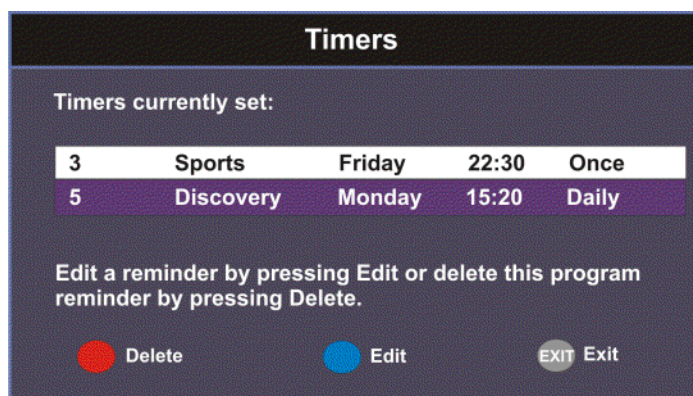

Step 2 From the Timers screen, scroll to the Timer profile you want to delete using the ▼▲ buttons.

Step 3 Select **Delete** or press the red button (**Delete**). A warning message appears confirming your deletion.

Step 4 Press **OK** to confirm.

Setting Up Your Favorite Channels

The Favorite screen displays a list of all the favorites configured in the D9865. Favorites allow you to surf through the channels you have set up as your favorite channels, skipping over other channels.

By default, **All Channels** (authorized and unauthorized channels) are displayed. The **Authorized Channels Only** lists channels that are authorized by your uplink provider. You can set up the list by performing a channel scan. For more information, see [Performing a Channel Scan, page 4-12](#).

Adding a Favorite Profile

Proceed as follows to configure your favorites list:

Step 1 From the **Main Menu** screen, select **Favorite** and press **OK**, or press **FAV**.

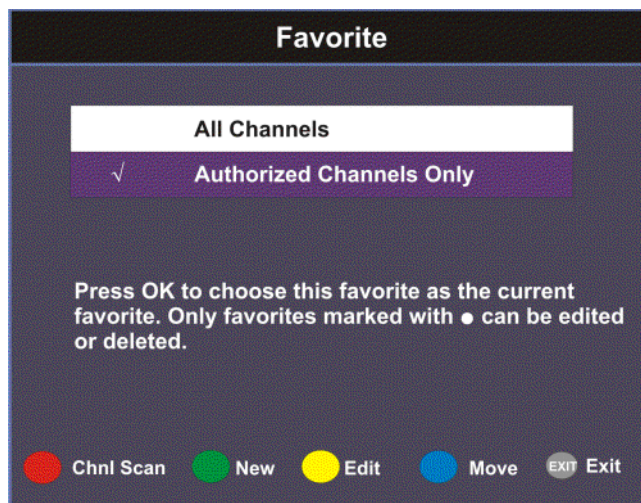

Step 2 Press the green button (**New**) to create a new Favorites list.

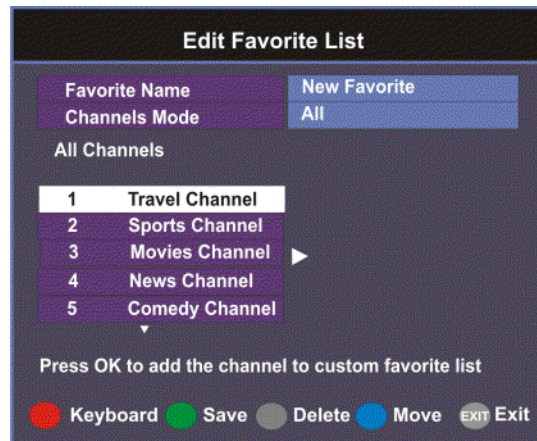

- Step 3** Select **Favorite Name** and press **OK** to edit the new favorite name. Enter the name directly using the numeric keypad on the remote control or use the ◀▼▲▶ buttons to change the letters/numbers one alphabet/digit at a time. Alternatively, press the red button (**Keyboard**) to enter the name using an on-screen keyboard.
- Step 4** Select the **Channel Mode** and press **OK** to select the type of channels listed below. Select **All** to list all the channels in the network. Select **Authorized Only** to list all the channels that are authorized by your uplink provider only.
- Step 5** Scroll through the channel list using the ▼▲ buttons and press **OK** to add the channels you want to your new favorites list on the right. A checkmark appears to the left of the channel, indicating that the channel is in the favorites list.
- Step 6** Press the ▶ button to edit the selected channels on the right. Press the blue button (**Move**) to move the selected channel up/down the list using ▼▲ buttons. When you are done moving the channel, press the blue button (**End Move**).
- Step 7** Press the green button (**Save**) to create and save the new Favorites list.

Editing a Favorite Profile



Note You cannot edit All Channels or Authorized Channels Only.

- Step 1** From the Favorite screen, scroll to the Favorite profile you want to edit using the ▼▲ buttons.
- Step 2** Press the yellow button (**Edit**). The Edit/Delete Custom Favorite screen is displayed.
- Step 3** Select Edit or press the blue button (**Edit**). The Edit Favorite List screen is displayed.
- Step 4** Make the necessary changes.
- Step 5** Press the green button (**Save**) to save the Favorites list.

Deleting a Favorite Profile



Note Only Favorites that are marked with a circle can be deleted.

- Step 1** From the Favorite screen, scroll to the Favorite profile you want to delete using the ▼▲ buttons.
- Step 2** Press the yellow button (**Edit**). The Edit/Delete Custom Favorite screen is displayed.
- Step 3** Select **Delete** or press the red button (**Delete**). A warning message appears confirming your deletion.
- Step 4** Press **OK** to confirm.

Performing a Channel Scan

The Channel Scan function scans through all the available channels and updates the Authorized Channels Only list. For more information on your authorized channels, contact your uplink service provider.

Proceed as follows to perform a channel scan:

- Step 1** From the Favorite screen, press the red button (**Chnl Scan**). A warning message appears confirming the channel scan. It can take several minutes, depending on the size of the network.
- Step 2** Press **OK**. The Authorized Channels Only list is updated.

Setting Up One Button Channel Change

Proceed as follows to set up one button channel change:

From the Main Menu, select **One Button Channel Change** and press **OK**.

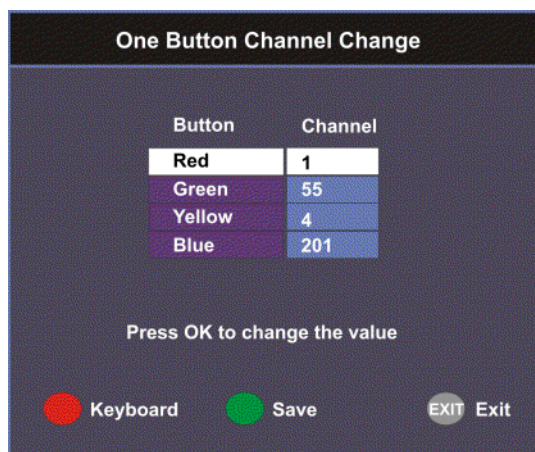

The Button colors (Red, Green, Yellow, and Blue) corresponds to the colored buttons at the bottom of the remote control (see below).



Each color can be assigned to a channel as a shortcut for a quick channel change. For example, if you assign the red button to channel 1, pressing the red button while watching a different channel at anytime will automatically tune the D9865 to TV channel 1.

**Note**

You can use the one button channel change if the screen is displaying video only. The one button channel change does not work if EPG, Channel Banner, or on-screen menus are displayed.

Setup Menu

The Setup Menu is used to set up the receiver.

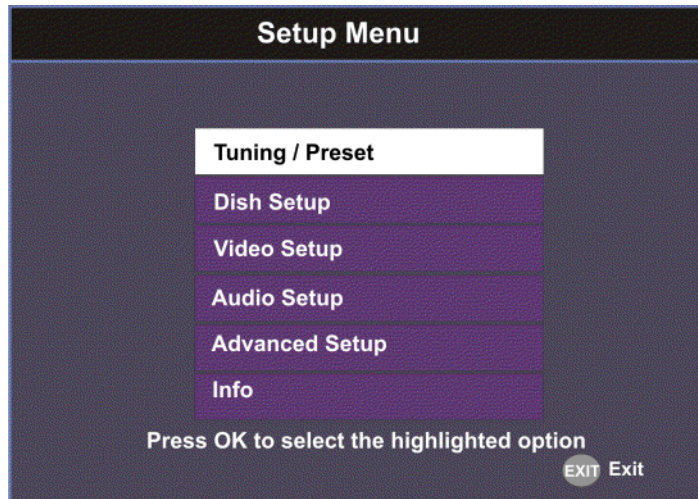

The available sub-menus are as follows:

- Tuning / Preset
 - From this menu, you can display and change Presets, and set up the LNB.
- Dish Setup
 - This menu provides a graphical aid for dish pointing/alignment.
- Video Setup
 - From this menu, you can set the TV channel to display video on your TV, the video format (e.g., NTSC or PAL), TV aspect ratio, and subtitling control.
- Audio Setup
 - From this menu, you can set the Stereo/Mono selection and select digital audio preferences.
- Advanced
 - From this menu, you can access other sub-menus for control and display of features such as Lock Level, Conditional Access, the Ethernet port and Diagnostics, and available services to control code downloads.
- Info
 - From this menu, you can access other sub-menus to display information about the receiver software, and hardware versions, view device status and other signal-related parameters.

Setting up Tuning / Preset

The Tuning/Preset menu is used to display and configure the current settings.

Proceed as follows to set up the tuning/preset:

- Step 1** From the **Setup Menu** screen, select **Tuning / Preset** and press **OK**.

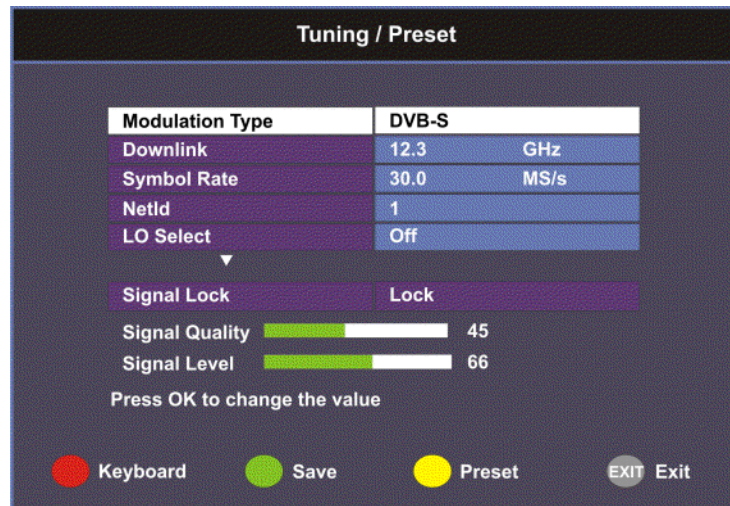

- Step 2** The following table describes each of the available options:

Selection	Options	Description	Default
Modulation Type	DVB-S DVB-S2	Enter the modulation scheme.	DVB-S2
Downlink (Freq)	Enter number	For C-Band: Downlink Freq = LO Freq - L-Band Freq. For Ku-Band: Downlink Freq = LO Freq + L-Band Freq.	12.3
Symbol Rate	1.0 to 45.0 1.0 to 31.0	Range for DVB-S in MS/s. Range for DVB-S2 in MS/s.	30.0
NetId	Enter number	Obtain the number from your service provider.	1

Selection	Options	Description	Default
LO Select (Sets a 22 kHz tone for Ku-band dual LNB)	On	Switches 22 kHz tone on.	Off
	Off	Switches 22 kHz tone off.	
	Auto	Sets 22 kHz tone to automatic. If Downlink Freq < Crossover, use LO Freq 1. The 22 kHz tone is Off. If Downlink Freq > Crossover, use LO Freq 2. The 22 kHz tone is On.	
LO Freq 1	Enter number	If C-band application, set to 5.15 GHz (default). If Ku-band single LNB, enter LO Freq. and set LO Freq 2 and Crossover to 0.0. If Ku-band dual LNB, enter LO Freq 1, LO Freq 2 and Crossover.	10.75 GHz
LO Freq 2	Enter number	Enter if Ku-band dual LNB application. LO Freq 2 > LO Freq 1.	0.0
Crossover	Enter number	Enter if Ku-Band dual LNB application. Determines if LO Freq 1 or LO Freq 2 is used for tuning.	0.0
LNB Power (For more information, see LNB Power Settings, page 4-21)	18-H	For H polarization (18V).	18-H
	13-V	For V polarization (13V).	
	Off	Use for external LNB power. LNB power must be on if DiSEqC is required.	
	H-NIT	Initially applies the horizontal polarization voltage, and then follows the polarization based on the NIT.	
	V-NIT	Initially applies the vertical polarization voltage, and then follows the polarization based on the NIT.	
DiSEqC	Enable Disable	Enables or disables Digital Satellite Equipment Control. This must be enabled to control the DiSEqC switch. LNB Power must be on to use this setting. Refer to http://www.eutelsat.com/satellites/4_5_5.html for more information.	Disable

Selection	Options	Description	Default
DiSEqC Switch	Off A to P	Selects a port on the LNB switch (if used)	Off
Signal Lock		Indicates signal synchronization status.	
Signal Quality		Indicates the quality of the received signal, associated with the Bit Error Rate, in the range from 0 to 100.	
Signal Level		Indicates the strength of the received signal in the range from 0 to 100.	

**Note**

If you enter an invalid frequency setting or a setting that does not correspond to the selection, a pop-up message such as "Input value out of range" is displayed.

Step 3 Press the green button (**Save**) to save and apply the settings to the receiver.

Setting up the Preset / LNB

The Preset/LNB Setup sub-menu allows you to select or configure up to 64 network presets. Your receiver may be shipped pre-configured with a number of network presets. You can configure the network preset to use one of 10 LNB configurations.

Proceed as follows to set up the preset/LNB settings:

Step 1 From the **Tuning / Preset** screen, press the yellow button (**Preset**) to set up the Preset/LNB.

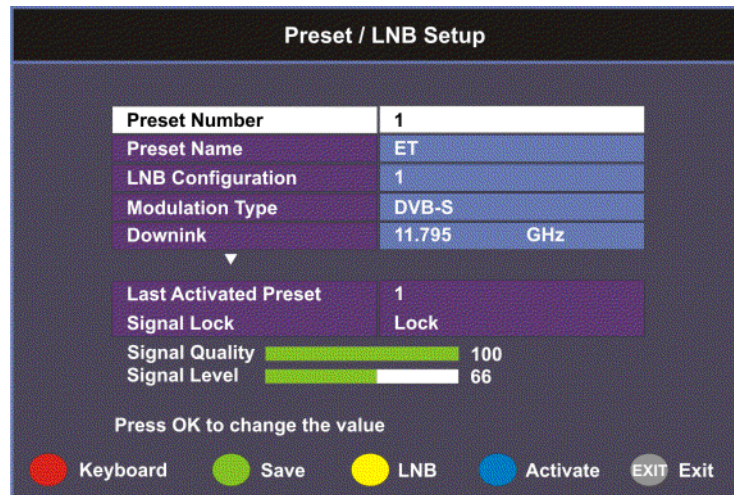

Step 2 The following table describes each of the available options:

Selection	Options	Description
Preset Number	1 to 64	Enter or select the preset number.
Preset Name	Enter name	Set the preset network name.
LNB Configuration	1 to 10	Enter or select the LNB configuration.
Modulation Type	DVB-S DVB-S2	Select the modulation scheme.
Downlink (Freq)	Enter number	For C-Band, Downlink Freq = LO Freq - L-band Freq. For Ku-Band, Downlink Freq = LO Freq + L-band Freq.
Symbol Rate	1.0 to 45.0 1.0 to 31.0	Range for DVB-S in MS/s. Range for DVB-S2 in MS/s.
NetId	Enter number	Obtain the number from your service provider.
Last Activated Preset		Indicates the number of the last activated preset.
Signal Lock		Indicates signal synchronization status.
Signal Level		Indicates the relative strength of the received signal, in the range from 0 to 100.

Step 3 Press the green button (**Save**) to save and apply the settings to the receiver.

Selecting the Active Preset

To change the displayed preset to the Active preset or to select a different preset as the active preset:

- Step 1** From the **Tuning/Presets** screen, press the yellow button (**Presets**).
- Step 2** Enter the preset in the **Presets** field that you want to activate. Enter the number directly using the numeric keypad on the remote control or use the ◀▼▲▶ buttons to change the number one digit at a time. Alternatively, press the red button (keyboard) to enter the preset using an on-screen keyboard.
- Step 3** Select **Activate** (blue button) to choose the preset. This will activate the currently displayed preset as the active preset.
- You will be prompted to accept the new preset and warned that service interruption will occur.
- Step 4** Select **OK** to proceed or **EXIT** to cancel the operation.
- Step 5** Press **MENU** to go to the previous menu.



Note It will take up to 30 seconds for signal acquisition to occur. It can take longer if the symbol rates are low.

Editing Network Presets

You can edit or pre-configure any one of 64 presets without affecting the operation of the receiver.

To save or change a network preset:

-
- Step 1** Enter a Preset Number and a name directly to below the Preset Number. Follow the editing rules for the keys when entering characters in the **Name** field.
 - Step 2** Enter the appropriate settings as described in the preceding table. Ensure that the LNB selection corresponds to the correct downlink frequency.
 - Step 3** Press **OK** to save the preset.
-

Setting up LNB

Proceed as follows to set up the LNB:

-
- Step 1** From the Preset/LNB Setup menu, press the yellow button (**LNB**) to set up the LNB.



Note You can configure up to 10 LNB presets.



- Step 2** The following table describes each of the options:

Selection	Options	Description
LNB Configuration	1 to 10	Number identifying the current preset LNB configuration.

Selection	Options	Description
LNB Power (For more information, see LNB Power Settings , page 4-21.)	18-H	For H polarization.
	13-V	For V polarization.
	Off	Use for external LNB power. LNB power must be on if DiSEqC is required.
	H-NIT	Initially applies the horizontal polarization voltage, and then follows the polarization based on the NIT.
	V-NIT	Initially applies the vertical polarization voltage, and then follows the polarization based on the NIT.
LO Freq1	Enter number	If C-band application, set to 5.15 GHz (default). If Ku-band single LNB, enter LO Freq. and set LO Freq 2 and Crossover to 0.0. If Ku-band dual LNB, enter LO Freq 1, LO Freq 2 and Crossover.
LO Freq2	Enter number	Enter if Ku-band dual LNB application. LO Freq 2 > LO Freq 1.
Crossover	Enter number	Enter if Ku-Band dual LNB application. Used to determine if LO Freq 1 or LO Freq 2 is used for tuning.
LO Select (Sets a 22 kHz tone for Ku-band dual LNB)	Off	Switches 22 kHz tone off.
	On	Switches 22 kHz tone on.
	Auto	Sets 22 kHz tone to automatic. If Downlink Freq < Crossover use LO1. The 22 kHz tone is Off. If Downlink Freq > Crossover use LO2. The 22 kHz tone is On.
DiSEqC	Enable	Enables or disables Digital Satellite Equipment Control. This must be enabled to control the DiSEqC switch. LNB Power must be on to use this setting. Refer to http://www.eutelsat.com/satellites/4_5_5.html for more information.
	Disable	
DiSEqC Switch	Off	Selects a port on the LNB switch (if used).
	A to P	

**Note**

If you enter an invalid frequency setting or a setting that does not correspond to the selection, a pop-up message such as "Input value out of range" is displayed.

Step 3 Press the green button (**Save**) to save your settings.

LNB Power Settings

The following table displays the LNB Power settings:

LNB Power Settings	NIT Contains	Output LNB Voltage
Off	Not received	Off
	H	Off
	V	Off
18-H	Not received	18 volts
	H	18 volts
	V	18 volts
13-V	Not received	13 volts
	H	13 volts
	V	13 volts
H-NIT	Not received	18 volts
	H	18 volts
	V	13 volts
V-NIT	Not received	13 volts
	H	18 volts
	V	13 volts

Setting Up the Satellite Dish

The **Dish Setup** menu provides graphical assistance for dish positioning. This menu can be set to two modes: User Mode (default) or Installer Mode. The User mode allows you to select from stored Satellite Numbers, which are stored satellite locations, as stored in the dish motor, but does not provide any dish control.

Proceed as follows to set up the dish:

- Step 1** From the **Setup** Menu, select **Dish Setup** and press **OK**. By default, the Dish Setup screen is displayed in User mode.

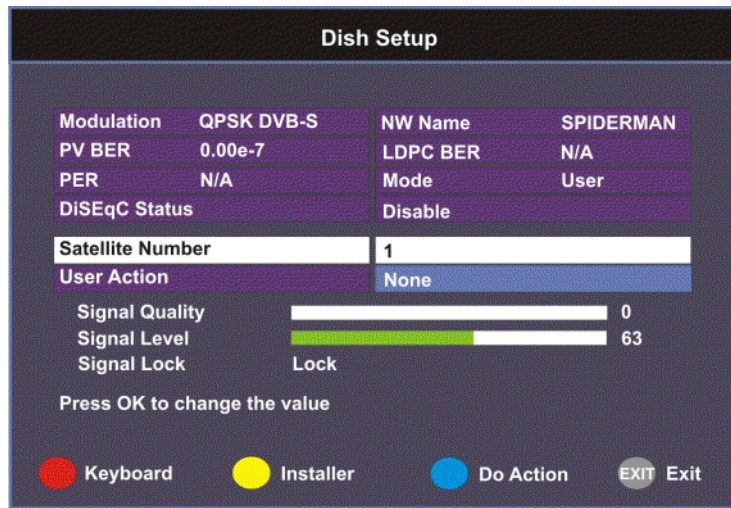

Step 2 The table at the top displays the current configurations.

Step 3 The following table describes each of the options in User mode:

Selection	Options	Description
Satellite Number	1 to 255	Number identifying the saved satellite location as defined by the dish motor manufacturer.
User Action	None	No action is performed.
	Goto Satellite	Moves the dish to the selected pre-stored satellite position. Satellite positions are stored in the dish motor, if supported, not in the receiver.

Step 4 Press the yellow button to switch between User and Installer modes. The Installer mode is for Installers only.

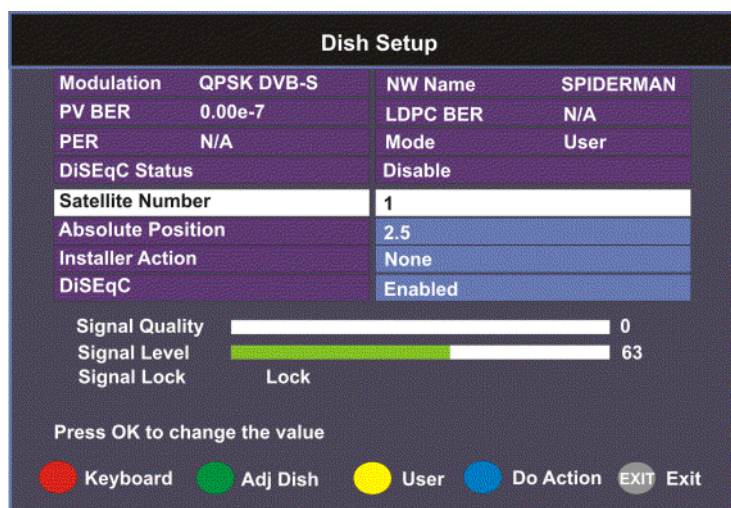

Step 5 The following table describes each of the available options for the Installer mode:

Selection	Options	Description
Satellite Number	1 to 255	Number identifying the saved satellite location as defined by the dish motor manufacturer.
Absolute Position	0.0 to 75.0	Position of the satellite in degrees.
Installer Action	Continuous West Movement	Moves the dish west until it reaches its limit. Ensure that the dish can move to its limit without any obstructions.
	Continuous East Movement	Moves the dish east until it reaches its limit. Ensure that the dish can move to its limit without any obstructions.
	Stop Move	Stops movement of the dish.
	Goto Absolute Position West	Moves the dish to the Absolute west position set above.
	Goto Absolute Position East	Moves the dish to the Absolute east position set above.
	Goto Reference	Moves the dish to a reference defined by the dish motor manufacturer.
	Goto Satellite	Moves the dish to the selected pre-stored satellite position. Satellite positions are stored in the dish motor, if supported, not in the receiver.
	Store Satellite	Stores the current dish position as a Satellite Number, if supported by the dish motor.
	Clear Limits	Clears the dish east and west limits stored in the dish motor.
	Store East Limits	Stores the current position as the east limit in the dish motor.
	Store West Limits	Stores the current position as the west limit in the dish motor.
Calculate Position	Updates the position of the dish according to the current position. For more information, refer to the dish manual provided by the dish manufacturer.	
None	No action is performed.	

Selection	Options	Description
DiSEqC	Enable	Enables or disables Digital Satellite Equipment Satellite Control.  Note This must be enabled to control the DiSEqC switch. LNB Power must be on to use this setting. Refer to http://www.eutelsat.com/satellites/4_5_5.html for more information. Before you can adjust the satellite position using the Adjust Dish Position screen or a signal tone, ensure that the LNB Power and DiSEqC (in the Tuning/Preset screen) are enabled.
	Disable	

Step 6 Press the blue button (**Do Action**) to save and apply the settings to the receiver until the next reboot.

Step 7 The following table describes the view-only information on the Dish Setup screen:

Parameter	Description
Modulation	Indicates the modulation type for the received signal.
LDPC BER	Indicates the bit rate of the input stream of the LDPC error correcting stage (DVB-S2 only).
Mode	Indicates whether the current dish setup mode is Installer or User. The mode can be changed by pressing the yellow button.
NW Name	Displays the network name.
PV BER	Indicates the PV (Post-Viterbi) BER for the received signal (DVB-S).
PER	Indicates the current PER (Packet Error Rate).
DiSEqC Status	Indicates whether the DiSEqC is enabled or disabled.
Signal Quality	Indicates the quality of the received signal, associated with the Bit Error Rate, in the range from 0 to 100.
Signal Level	Displays the relative strength of the received RF input signal. It is displayed in the range from 0 to 100.
Signal Lock	Indicates whether the receiver is synchronized with the received RF signal.

Adjusting the Satellite Position in Installer Mode

To adjust the satellite position, the DiSEqC must be set to Enable.

- Step 1** On the Dish Setup screen, press the yellow button (**Installer**) to select Installer mode.
- Step 2** Ensure the DiSEqC is set to Enable and then press the green button (**Adj Dish**).

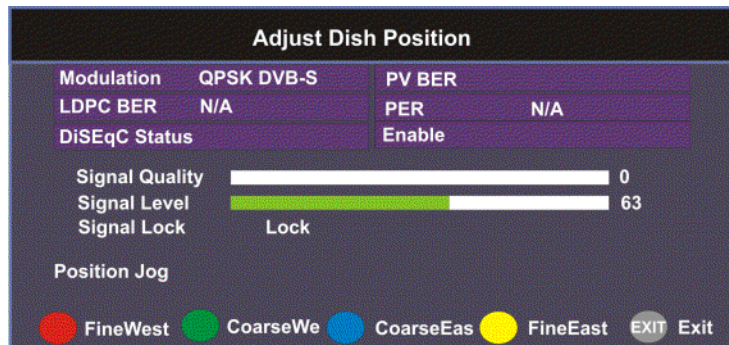

- Step 3** Press the red or yellow button for fine west and east dish adjustment. Press the green or blue button for coarse east and west dish adjustment.

Changing the Satellite Position in User Mode

To select a new satellite position on the Dish Setup menu:

- Step 1** Use the ▲▼ buttons to move to Satellite Number and press **OK**.
- Step 2** Enter the pre-stored satellite number you want to use in the range from 1 to 255, and press **OK**.
- Step 3** Press ▼ to move down to User Action and press **OK**.
- Step 4** Press ► to choose **Goto Satellite** and press **OK**. The receiver is now tuned to the selected satellite position.
- Step 5** Press **MENU** to move to the previous menu, or **EXIT** to go to video.

Adjusting the Satellite position using Signal Tones

Dish alignment can be done using the audible signal adjustment tone. The characteristics of the signal tone are shown in the table below. Align the dish to achieve signal lock and then best signal quality.



Note

The signal adjustment tone automatically outputs as PCM audio type only, regardless of the Digital Audio Preference set in Audio Setup.

Signal Lock/Quality	Tone
No Signal Lock	Slow repeating tone.
Signal Lock	Steady tone.
Signal Lock + increasing Signal Quality	Steady tone increasing in pitch.

Provided the RF cable is connected between the satellite receiver and the LNB, Signal level displays a low number (typically less than 40). As the receiver achieves Signal Lock, the Signal Level increases, and the tone changes from a slow repeating beep to a steady tone. Once Signal Lock is obtained, align the dish to increase the Signal Quality to the best possible value (up to a maximum of 10).

Signal Level and Signal Quality

The **Signal Level** and **Signal Quality** of the incoming signal are displayed both numerically and graphically using bar graphs.

The **Signal Level** is associated with the RF input signal level. The **Signal Level** display is continuously updated to indicate the relative strength of the received RF input signal. It is displayed in the range from 0 to 100. **Signal Level** is displayed on the **Tuning / Preset** and **Dish Setup** menus both numerically and graphically.

The **Signal Quality** (displayed in the range from 0 to 100) is associated with the Bit Error Rate, and is a measure of the signal quality. **Signal Quality** is displayed both numerically and graphically on the **Dish Setup** menu. To obtain the best signal quality, adjust the dish position to obtain the highest **Signal level** and **Signal Quality** possible.

Temporary, solar-related electromagnetic disturbances occur every year during the spring and autumn months. These disturbances usually persist for several minutes a day for approximately one week at this time. Your service provider can advise you about channels that may be adversely affected.

To verify your satellite LNB antenna installation or improve signal reception, refer to your antenna equipment installation manual, or contact your local service provider.

Signal Lock

The Signal Lock status is continuously updated to indicate whether the receiver is synchronized with the received satellite RF signal. Signal Lock status is displayed on the Preset / LNB Setup and Dish Setup menus.

If the receiver is able to synchronize to a carrier frequency and an MPEG stream is present, Signal Lock displays Lock and the Signal LED on the receiver front panel is on. If no carrier is detected, Signal Lock displays No Lock and the Signal LED is off.

Setting up the Video

The video format is set to the standard format for your country. If you attempt to change the format of the source video signal, a warning message appears, to inform you that if the fields are incorrectly configured, the display may not be viewable. Check with your satellite or local service provider before changing the video settings to ensure it is set correctly. Press **OK** to continue with the edit. Otherwise, select **Cancel**.

**Note**

If an error was made when changing the video settings, you can set the TV video format using the front panel. For more information, see [Setting the TV Video Format, page 3-3](#).

Proceed as follows to set up the video information:

From the **Setup Menu** screen, select **Video Setup** and click **OK**.



The following table describes each of the options in the Video Setup screen.



Selection	Options	Description	Default
HD Video Output	Auto	Receiver automatically detects correct HD video format.	Auto
	HD 1080i	Sets the HD output video format.	
	HD 720p		
SD Video Output	Auto	Receiver automatically detects correct SD video format.	Depends on TV modulator installed
	PAL-B/G, PAL-D, PAL-I	For 625-line systems.	
	PAL-M	525-line format for Brazil.	
	PAL-N (AR)	625-line format for Argentina.	
	NTSC, NTSC-J	For 525-line systems.	
TV Channel	3 or 4 for NTSC 21-69 for PAL	Sets TV channel for video display.	3 or 21, depending on TV modulator installed.
TV Aspect Ratio	4:3, 16:9	The aspect ratio of the intended TV system.	4:3

Selection	Options	Description	Default
Aspect Ratio Convert	None	This is the conversion that the receiver will perform on the incoming signal for the picture to be displayed correctly (i.e., to correspond to the aspect ratio of your TV) on your TV, based on your selection. For the actual conversion performed, refer to Actual Conversion Table, page 4-28 .	None
	Auto		
	Auto AFD		
	16:9 L/B		
	4:3 P/B		
	14:9		
	4:3 CCO		
	16:9 SCALE		
Closed Caption	Auto	This is the mode of closed-captioning to use, if there are multiple in the stream.  Note SA Custom is not supported when telecine video coding is enabled.	Auto
	SA Custom		
	EIA 708		
	Type 3		
	Type 4 SA		
	Type 4 ATSC		
	Reserved		
	DVB 157		
Stream Aspect Ratio	4:3, 16:9	This indicates the aspect ratio of the incoming signal. This is read-only.	
Actual Conversion		This is the type of (aspect ratio) conversion the receiver will perform based on what you have selected. This is read-only.	

Actual Conversion Table

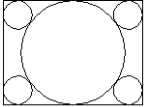
The following table displays the actual conversion performed by the receiver according to your TV Aspect Ratio selection and the affect on the picture displayed on the TV screen.

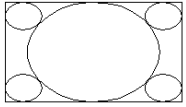
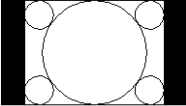
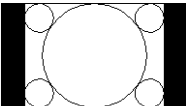
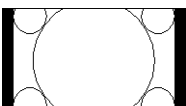
Stream	TV Aspect Ratio	Aspect Ratio Conversion	Actual Conversion	Description	Image
4:3	4:3	None	None	Normal Picture	 4:3
4:3	4:3	Auto	None	No conversion	
4:3	4:3	16:9 L/B	None	Conversion is not possible. Normal picture.	
4:3	4:3	4:3 CCO	None	Conversion is not possible. Normal picture.	

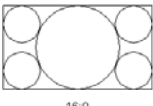
Stream	TV Aspect Ratio	Aspect Ratio Conversion	Actual Conversion	Description	Image
4:3	4:3	4:3P/B	None	Conversion is not possible. Normal picture.	
4:3	4:3	14:9	None	Conversion is not possible. Normal picture.	
4:3	4:3	16:9 SCALE	None	Conversion is not possible. Normal picture.	
4:3	16:9	None	None	Picture is short & wide.	 4:3 Stretch
4:3	16:9	Auto	4:3 P/B	Uses 4:3 P/B.	 4:3 PB
4:3	16:9	4:3 P/B	4:3 P/B	4:3 picture is centered in a pillar-style box.	 4:3 PB
4:3	16:9	14:9	14:9	Compromises some up-sampling. Some black bars and cropping are visible.	 14:9
4:3	16:9	16:9 SCALE	16:9 SCALE	Vertically up-samples the center of the 4:3 picture and crops the top and bottom of the screen.	 16:9 FH
16:9	16:9	None	None	Normal	 16:9
16:9	16:9	Auto	None	No conversion. Normal picture.	
16:9	16:9	16:9 L/B	None	Conversion is not possible. Normal picture.	
16:9	16:9	4:3 CCO	None	Conversion is not possible. Normal picture.	

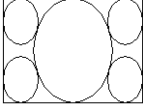
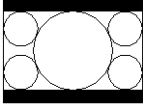
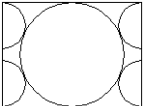
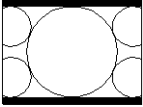
Stream	TV Aspect Ratio	Aspect Ratio Conversion	Actual Conversion	Description	Image
16:9	16:9	4:3 P/B	None	Conversion is not possible. Normal picture.	
16:9	16:9	14:9	None	Conversion is not possible. Normal picture.	
16:9	16:9	16:9 SCALE	None	Conversion is not possible. Normal picture.	
16:9	4:3	None	None	Picture appears tall and thin.	 16:9 Compressed
4:3	16:9	16:9 L/B	None	Conversion is not possible. Picture appears short and wide.	
4:3	16:9	4:3 CCO	None	Conversion is not possible. Picture appears short and wide.	
16:9	4:3	16:9 L/B	16:9 L/B	Vertically down-samples the picture and applies black bars at the top and bottom of the screen.	 4:3 LB
16:9	4:3	4:3 CCO	4:3 CCO	Horizontally up-samples the center portion of the picture to fill the screen.	 4:3 Crop
16:9	4:3	4:3 P/B	None	Conversion is not possible. Picture appears tall and thin.	
16:9	4:3	14:9	14:9	Compromises some up-sampling. Some black bars and some cropping are visible.	 14:9
16:9	4:3	16:9 SCALE	None	Conversion is not possible. Picture appears tall and thin.	

Video Output Restrictions

The following table describes the nature of the Video Outputs given the source video stream and selections that can be made by the user. The D9865 does not provide video format conversion.

Source Video Format	User Selected SD Format	User Selected HD Format	Component & HDMI	CVBS & TV-Out
SD-NTSC (60Hz)	Auto or NTSC	Auto	1080i 60Hz	NTSC
		1080i	1080i 60Hz	NTSC
		720p	720p 30Hz	NTSC
	PAL (50 Hz)	Any	Mismatch	Mismatch
SD-PAL (50Hz)	Auto or PAL	Auto	1080i 50Hz	PAL
		1080i	1080i 50Hz	PAL
		720p	720p 25Hz	PAL
	NTSC	Any	Mismatch	Mismatch
1080i 60Hz	Auto or NTSC	Auto	1080i 60Hz	NTSC
		1080i	1080i 60Hz	NTSC
		720p	720p 30Hz	NTSC
	PAL	Any	Mismatch	Mismatch
1080i 50Hz	Auto or PAL	Auto	1080i 50Hz	PAL
		1080i	1080i 50Hz	PAL
		720p	720p 25Hz	PAL
	NTSC	Any	Mismatch	Mismatch
720p 30Hz	Auto or NTSC	Auto	720p 30Hz	NTSC
		1080i	1080i 60Hz	NTSC
		720p	720p 30Hz	NTSC
	PAL	Any	Mismatch	Mismatch
720p 25Hz	Auto or PAL	Auto	720p 25Hz	PAL
		1080i	1080i 50Hz	PAL
		720p	720p 25Hz	PAL
	NTSC	Any	Mismatch	Mismatch

Video formats that require a frame rate change from the original source stream are blocked by a “Video Format Mismatch” banner and the video output is muted.

Setting up Subtitles

The Subtitle Setup screen allows you to configure the type of subtitling (i.e., DVB or Imitext displayed by the receiver, and how the receiver displays subtitling on TV.

Proceed as follows to set up subtitling:

From the **Video Setup** screen, press the yellow button (**Subtitle**).

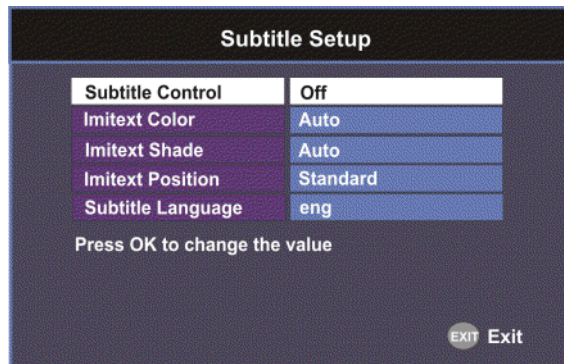

The following table describes each of the options on the Subtitle Setup screen:

Selection	Options	Description	Default
Subtitle Control	Off	No subtitles are displayed	Off
	On	Functions as an “Auto” setting. DVB subtitles are displayed when only DVB subtitles are transmitted on the channel, and likewise, Imitext subtitles are displayed when only Imitext subtitles are transmitted on the channel. When both DVB and Imitext subtitles are available on the same channel, only DVB subtitles will be displayed.	
	Imitext	Displays only Imitext subtitles. For example, if Imitext is selected, but both DVB and Imitext subtitles are being transmitted on the same channel, only Imitext subtitles will be displayed.	
	DVB	Displays only DVB subtitles. For example, if DVB is selected, but both DVB and Imitext subtitles are being transmitted on the same channel, only DVB subtitles will be displayed.	

Selection	Options	Description	Default
Imitext Color (text color)	Auto	Displays text in the color transmitted by the subtitling equipment.	Auto
	Yellow	Displays text in yellow.	
	White	Displays text in white.	
Imitext Shade (background color)	Auto	Displays background in same shade transmitted by the subtitling equipment.	Auto
	Shadow	Applies an outline to the right side of each text character. No background box is applied to subtitles, i.e., text is visible directly on top of video.	
	Opaque	Applies a black box to each text character.	
	Semi	Applies a semi-transparent box to subtitle text.	
	None	No shadow or outline is applied to subtitle text.	
Imitext Position	Standard	Subtitles appear on screen in same position as output from other PowerVu receivers.	Standard
	Extended	Subtitles are positioned on screen according to the Imitext (extended) specification.	
Subtitle Language	Available languages	Select from any one of the available languages.	eng (English)

Setting up Audio

Proceed as follows to select the audio source.

From the **Setup Menu** screen, select **Audio Setup** and click **OK**.

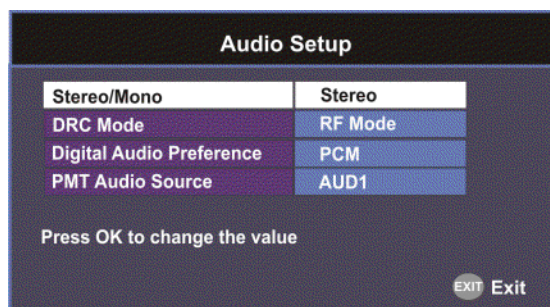

The following table describes each of the options:

Selection	Options	Description	Default
Stereo/Mono	Stereo	Left and right channels are output on L and R respectively.	Stereo
	Mixed	Left and right channels are combined and output on both L and R.	
	L-MONO	Left channel is output on L and R.	
	R-MONO	Right channel is output on L and R.	
DRC Mode	RF Mode	This setting is normally used for analog cable modulators, when limited dynamic range is desired.	RF Mode
	Line Mode	Setting used when full dynamic range is allowed.	
Digital Audio Preference	PCM	Set the compressed audio type.	PCM
	Dolby Digital	For more information on the settings, see the Digital Audio Preference Settings table below.	
	Compressed (Dolby Digital Plus)		
PMT Audio Source	None	Select the PMT Audio Source for the audio channel.	AUD1
	AUD1 to AUD64		

Digital Audio Preference Settings

The following table displays the effects of Dolby Audio Preference setting on audio outputs, based on the type of audio being decoded:

Input/Output	Digital Audio Preference			
	PCM	Dolby Digital	Compressed	
			S/PDIF	HDMI
MPEG LA (MPEG1 and MPEG2)	PCM	PCM	PCM	PCM
Dolby Digital	PCM	Dolby Digital (follows IEC 61937)	Dolby Digital (follows IEC 61937)	Dolby Digital (follows IEC 61937)
Dolby Digital Plus (< 1.5 Mbps)	PCM	Dolby Digital (follows IEC 61937)	Dolby Digital Plus (No over-clocking, follows SMPTE-338)	Dolby Digital Plus (over-clocking x4, follows IEC 61937)

Input/Output	Digital Audio Preference			
	PCM	Dolby Digital	Compressed	
			S/PDIF	HDMI
Dolby Digital Plus (≥ 1.5 Mbps)	PCM	Dolby Digital (follows IEC 61937)	Dolby Digital (follows IEC 61937)	Dolby Digital (follows IEC 61937)
MPEG2 AAC, MPEG4 (AAC and HEAAC v1 and v2)	PCM	MPEG2 AAC, MPEG4 (AAC and HEAAC) (follows IEC 61937)	MPEG2 AAC, MPEG4 (AAC and HEAAC) (follows IEC 61937)	MPEG2 AAC, MPEG4 (AAC and HEAAC) (follows IEC 61937)

Viewing Advanced Settings

Proceed as follows to view the Advanced Setup screen.

From the **Setup Menu** screen, select **Advanced Setup** and press **OK**.

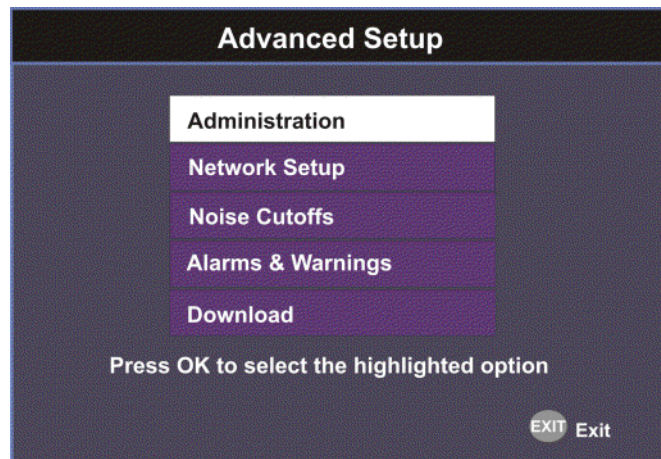

The function for the available sub-menus is as follows:

- Administration
 - From this menu, you can display and control the Lock level, date and time, and other settings.
- Network Setup (D9865D only)
 - From this menu, you can configure the receiver for Ethernet operation.
- Noise Cutoffs
 - From this menu, you can set the noise thresholds.
- Alarms & Warnings
 - From this menu, you can configure alarm and warning settings.
- Download
 - From this menu, you can control and view the status of a code download.

Setting up Advanced User Settings

Proceed as follows to set up the advanced user settings:

From the **Advanced Setup** screen, select **Administration** and press **OK**.

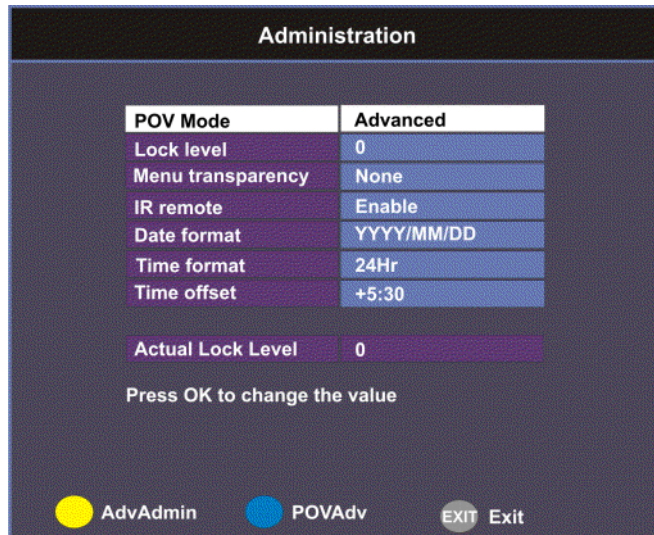

The following table describes each of the options:

Selection	Options	Description	Default
POV Mode	Standard	Configures the network controls to the following pre-defined settings: CA Mode - Std Acquisition Mode - Basic	Standard
	Open	Configures the network controls to the following pre-defined settings: CA Mode - Open Acquisition mode - Auto	
	Advanced	Enables the POVAdv menu option, allowing you to customize the CA Mode and Acquisition settings. For more information, see Setting up POV Mode, page 4-40 .	
Lock level	0 to 3	Restricts access and prevents unauthorized changes to receiver settings. For details on changing the lock level, see Changing the Lock Level, page 4-38 .	

Selection	Options	Description	Default
Menu transparency	None, 25%, 50%, 75%, 90%	Set the transparency level of the menus displayed on-screen. For example, if set to None, menus are solid and the video appears behind the menus. If set to 25%, menus are clear and the video is visible through the menus.	None
IR remote	Enable	Set to Enable to control the receiver using the remote control. By default, the receiver is shipped with the remote control enabled.  Note The EPG functions are only available using the IR remote control.	Enable
	Disable	Set to Disable if you want to disable the remote control and use the front panel controls only.	
Date Format	YYYY/MM/DD, DD/MM/YYYY, MM/DD/YYYY	Current date information is displayed in the Active Alarm and Active Warning screens.	YYYY/MM/DD
Time format	24 Hr, 24 Hr SuspendZero, 12 Hr, 12 Hr SuspendZero	Time information is displayed in the Active Alarm and Active Warning screens. Time information is normally broadcast as part of the transmitted digital signal, and is usually the broadcaster local time relative to Greenwich Mean Time (GMT).	24 Hr
Time offset	Adjusted in one hour increments, from -12:00 to +13:00, and GMT.	Displays the time zone offset instead of the true local time. If the current broadcast time is not your local time, you must change this time setting.	+05:30
Actual Lock Level		Displays the current lock level.	
Adv Admin		Displays the Advanced Administration screen. For more information, see Changing the Lock Level Password , page 4-38.	

Changing the Lock Level

Receiver lock levels are password-protected. When an attempt is made to change the lock level setting, a password prompt is displayed. After the correct password is entered, you can change the lock level setting.

If the incorrect password is entered (any lock level setting), a message box appears on-screen to confirm an invalid password entry, and access to the locked options are denied.

Note

The default password is 1234.

For details on the four lock levels, see [D9865 Satellite Receiver Lock Levels, page C-1](#).

Proceed as follows to change the lock level:

- Step 1** In the **Administration** menu, scroll to select **Lock Level** and press **OK**. The PIN Entry screen appears.
- Step 2** Press **OK** to enter the current password using the numeric keypad on the remote control and press **OK**. For security reasons, a default character is substituted for each button pressed.
- Step 3** Use **◀▶** to select a valid lock level (lock levels are displayed from 0 to 3) and then press **OK**. The default setting is 0. The Actual Lock Level parameter below is updated to the new lock level.

Menu options change color (view-only) if disabled by the current lock level setting.

Note

A virtual channel displayed for 20 seconds or more automatically becomes the current (Last) channel. As Lock Level 3 disables most Lock Level 0 functions (including channel changes), perform this action before changing the current Lock Level setting to 3.

Changing the Lock Level Password

The Advanced Administration sub-menu allows you to change the following:

Set Lock Level Password - to change the current lock level password (1234).

Factory Reset - to restore the receiver to factory default settings.

A unique lock level password (4-digit password) protects the current receiver settings against unauthorized changes. When changing the password, record and keep this number in a secure location. The default password is 1234.

Caution

Proceed with caution when changing the password as this operation cannot be undone. If the password is lost or is unavailable, contact Cisco customer support.

To change the lock level password:

- Step 1** From the **Administration** screen, press the yellow button (**Adv Admin**).

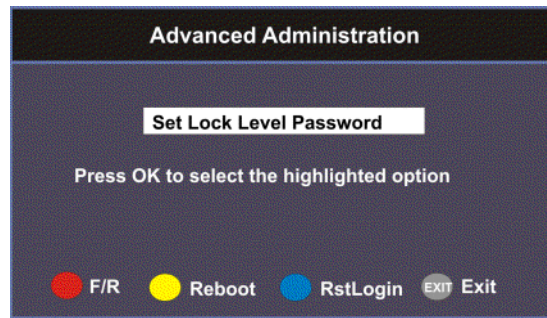

- Step 2** Select **Set Lock Level Password** and press **OK**.
- Step 3** Press **OK** to enter the current password and press **OK**. For security, a default character is substituted for each button pressed.
- Step 4** Press **OK** to enter the new password, any number from 0 to 9, and press **OK**.
- Step 5** Press **OK** to enter the new password again for password confirmation and press **OK**. A message appears informing you that the password was changed successfully.



Note If the password is lost or is unavailable, contact Cisco customer support.

Performing a Factory Reset

The Factory Reset (**F/R**) is used for restoring the receiver's factory presets (defaults). When activated, the current receiver settings are replaced by the default settings. After the factory defaults are restored, you can change the receiver settings as required.

To restore the factory default settings using the remote control:

- Step 1** From the **Advanced Administration** screen, press the blue button (**F/R**).
- Step 2** Select **Yes** to reset the receiver and restore to factory defaults. Select **No** to cancel the operation.

Following a factory reset, the receiver returns to Standby mode. Wait for the flashing front panel LED, and then press the **Display** button on the remote control or front panel, followed by the **Menu** button to return to the Main Menu.

Rebooting the Receiver

If you need to reboot the receiver for any reason, you can perform this function without changing any settings.

To reboot the receiver:

- Step 1** From the **Advanced Administration** screen, press the yellow button (**Reboot**). A message appears confirming that you want to reboot the receiver.

Step 2 Select **Yes** to reboot. Otherwise, select **No**.

Resetting the Web GUI Login Information

The Reset Login (**RstLogin**) is used for resetting the username and password used for Web GUI login to its default values. The default username is admin and the default password is localadmin.

To reset the login:

Step 1 From the **Advanced Administration** screen, press the blue button (**RstLogin**). A message appears confirming that you want to reset the password to its default values.

Step 2 Select **Yes**. Otherwise, select **No**.

Setting up POV Mode

Proceed as follows to configure the POV Mode:



Note Ensure the **POV Mode** setting is set to **Advanced**.

Step 1 From the **Administration** screen, press the blue button (**POVAdv**).

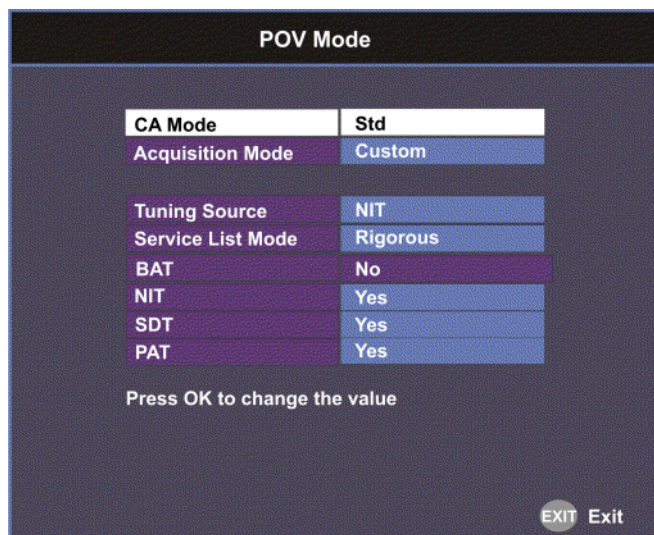

Step 2 Select the Conditional Access type (**CA Mode**) that determines which programs can be viewed via the satellite receiver. Select **Std** (preferred) or **Open**. The default is **Std**.



Caution In Open mode, the receiver ignores inconsistent scrambling descriptions within the signal. Operating in this mode may cause the decoder not to respond to certain advanced uplink controlled features, such as service replacement.

- Step 3** Set the **Acquisition Mode** used to build channel lists from allowed service lists (Basic, Auto, or Custom). Select Custom to customize the tables used to obtain tuning and channel lists.
- Step 4** If the **Acquisition Mode** was set to **Custom**, you can set the **Tuning Source** to indicate whether the receiver is tuned to the received signal using the NIT or a Preset. The default is NIT.
- Step 5** The **Service List Mode** indicates which tables are used to obtain tuning and channel lists. This only applies when Acquisition Mode is set to **Custom**. Select **Rigorous** if all default settings must be present in the received signal. Select **Degraded** and only the table parameters present in the received signal will be used to install the receiver.

The following table displays the default settings for the allowed service lists and frequency tuning settings.

Allowed Service lists	Auto	Basic	Custom
BAT	No	No	No
NIT	Yes	Yes	No
SDT	Yes	No	No
PAT	Yes	No	Yes
Tuning Source	NIT	NIT	Preset

Viewing the Network Setup Menu (D9865D only)

Proceed as follows to view the Network Setup screen (D9865D only).

From the **Advanced Setup** menu, select **Network Setup** and press **OK**.

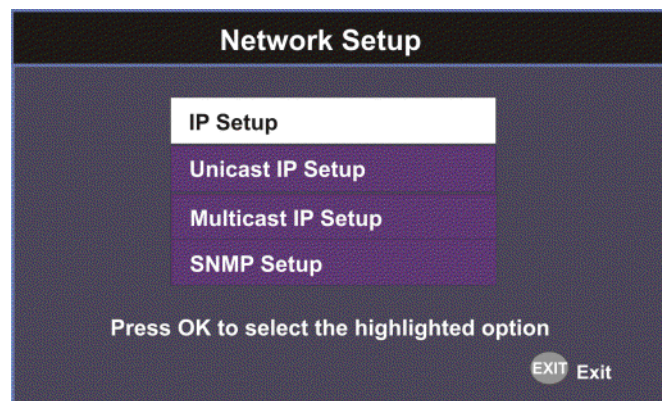

The function for the available sub-menus is as follows:

- IP Setup
 - From this menu, you can configure the receiver for Ethernet operation.
- Unicast IP Setup
 - From this menu, you can configure network destinations for unicast transmission.
- Multicast IP Setup

- From this menu, you can configure network destinations for multicast transmission.
- SNMP Setup
 - From this menu, you can configure the password to read and write data to a device. You can also configure trap destinations.

Configuring IP Setup

The IP Setup screen allows you to set the parameters for communicating with other equipment via the Ethernet Data and Management ports for MPE applications. The D9865 supports unicast and multicast IP streaming. There are two Ethernet ports (Port 1 and Port 2). Click the blue button (**Next Port**) in the IP Setup menu to toggle between the two ports.



Note

Only Port 1 is available for this release.

MPE Output

The Multiprotocol Encapsulation (MPE) output provides a means to carry packet oriented IP protocols on top of a transport stream. The MPE output receives IP packets from the transport stream and the IP data can be sent through an Ethernet switch to an IP router or directly to a receiving device.

The diagram below shows an example of the D9865 receiver used in an MPE application.

Figure 4-1 D9865 in MPE Application

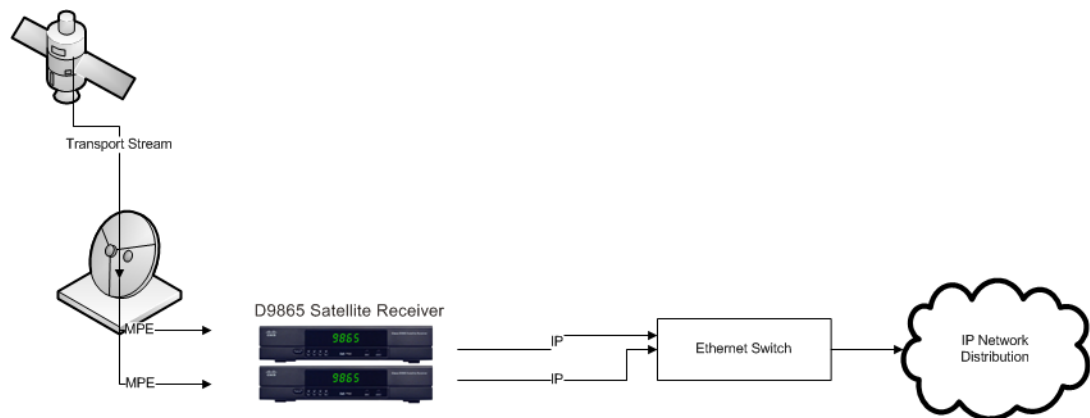

Setting the Filter Mode

The filter mode sets the multicast forwarding for MPE data output.

Proceed as follows to set up the filter mode:

- Step 1** From the **Advanced Setup** screen, select **IP Setup** and press **OK**.

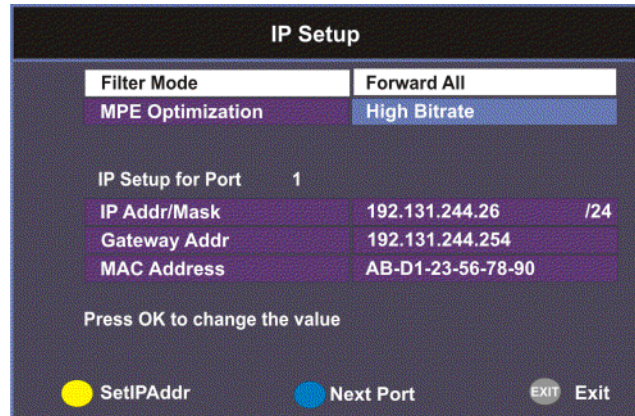

- Step 2** The **Filter Mode** sets whether all the MPE data is forwarded (**Forward All**). It can forward up to 5 PIDs at the maximum bit rates shown in the following table. Otherwise, select Forward None.

MPE Bit Rate	No Decoding	5 Mbps SD Video Decoded	20 Mbps HD Video Decoded
Multicast	30 Mbps	20 Mbps	15 Mbps
Unicast	20 Mbps	15 Mbps	10 Mbps

- Step 3** Set the **MPE Optimization** setting. Select **High Bitrate** (default) to accumulate the IP packets before they are processed in short bursts, increasing the allowable bit rate of MPE data. Select **Low Jitter** to emit the IP packets in a constant stream, resulting in low latency.

Editing an IP Address

Proceed as follows to edit the Network IP Address:

- Step 1** From the **IP Setup** screen, press the yellow button (**SetIPAddr**).



- Step 2** Make the necessary changes. The following table describes each of the options:

Selection	Options	Description
IP Address	12 digits in length (###.###.###.###)	Sets the IP Address for its participation in a Network environment.
Mask	8 to 32	Sets the Subnet Mask for its participation in a Network environment.
Gateway Address	12 digits in length (###.###.###.###)	Sets the Network Gateway Address on the Network, used to expose the receiver to a WAN.

The Network Address, Prefix Mask, and Gateway Address should be changed together, as a group. The following table shows the most commonly used Subnet mask values to enter for a chosen IP address mask, which will depend on the size of your network.

Mask	Subnet Mask
8	255.0.0.0
16	255.255.0.0
24	255.255.255.0



Note Only Port 1 is available for this release.

- Step 3** Press the green button (**Save**) to save your changes.

Setting the Unicast IP Address

Viewing the Unicast IP

Unicast transmission is used to send messages to a specific address. You can specify up to six single network destinations. The Gateway address is necessary if the network address is not on a local network.

Proceed as follows to view the Unicast IP addresses:

From the **Network Setup** screen, select **Unicast IP Setup** and click **OK**.

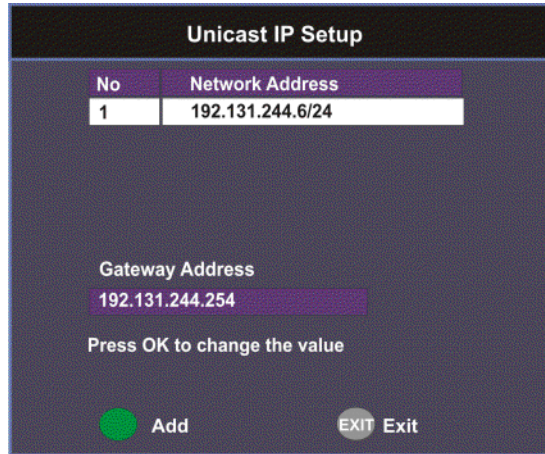

The Unicast IP Setup screen lists all the IP addresses and its Gateway addresses that are participating in a Network environment.

Adding a Unicast IP Address

Proceed as follows to add a Unicast IP Address:

-
- Step 1** From the **Unicast IP Setup** screen, press the green button (**Add**) to add a new address.

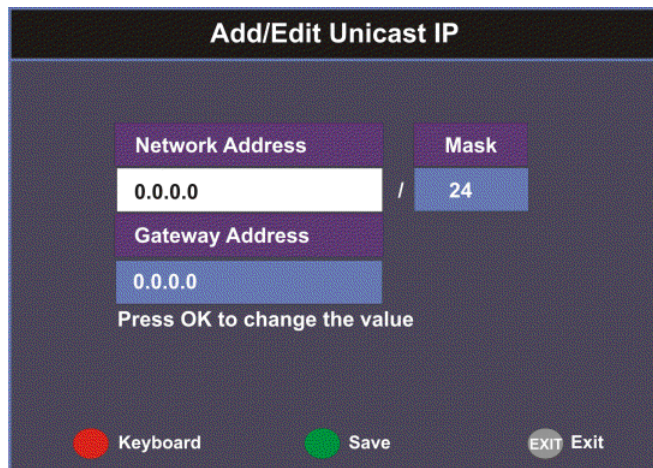

- Step 2** Make the necessary changes. The following table describes each of the options:

Selection	Options	Description
Network Address	12 digits in length (###.###.###.###)	Sets the IP Address for its participation in a Network environment.
Mask	8 to 32	Sets the Subnet Mask for its participation in a Network environment.
Gateway Address	12 digits in length (###.###.###.###)	Sets the Network Gateway Address on the Network, used to expose the receiver to a WAN.

The Network Address, Mask, and Gateway Address should be changed together, as a group. The following table shows the most commonly used Subnet mask values to enter for a chosen IP address mask, which will depend on the size of your network.

Mask	Subnet Mask
8	255.0.0.0
16	255.255.0.0
24	255.255.255.0

Step 3 Press the green button (**Save**) to save your changes.

Editing a Unicast IP Address

- Step 1** In the Unicast IP Setup screen, scroll to the unicast IP you want to edit using the ▼▲ buttons.
- Step 2** Press **OK**. The Edit/Delete Unicast IP screen is displayed.
- Step 3** Select **Edit** or press the blue button (**Edit**). The Add/Edit Unicast IP screen is displayed.
- Step 4** Make the necessary changes.
- Step 5** Select the green button (**Save**).

Deleting a Unicast IP Address

- Step 1** In the Unicast IP Setup screen, scroll to the unicast IP you want to delete using the ▼▲ buttons.
- Step 2** Press **OK**. The Edit/Delete Unicast IP screen is displayed.
- Step 3** Select **Delete** or press the red button (**Delete**). A message appears to confirm the deletion.
- Step 4** Press **OK**.

Setting the Multicast IP Address

Viewing the Multicast IP Addresses

Proceed as follows to view the Multicast IP addresses:

From the **Network Setup** screen, select **Multicast IP Setup** and click **OK**.

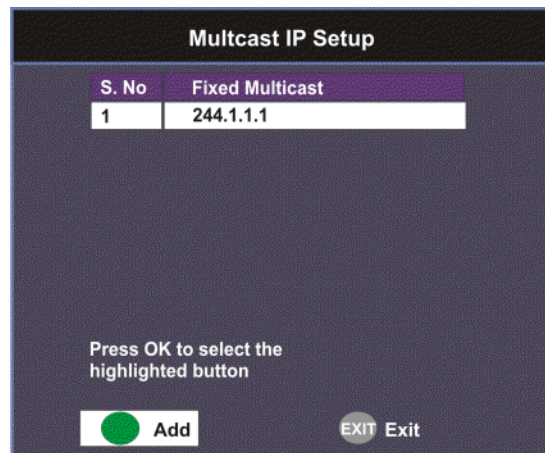

The Multicast IP Setup screen lists all the fixed multicast destination IP addresses.

Adding a Multicast IP Address

Proceed as follows to add a Multicast IP Address:

- Step 1** From the **Multicast IP Setup** screen, press the green button (**Add**) to add a new address.

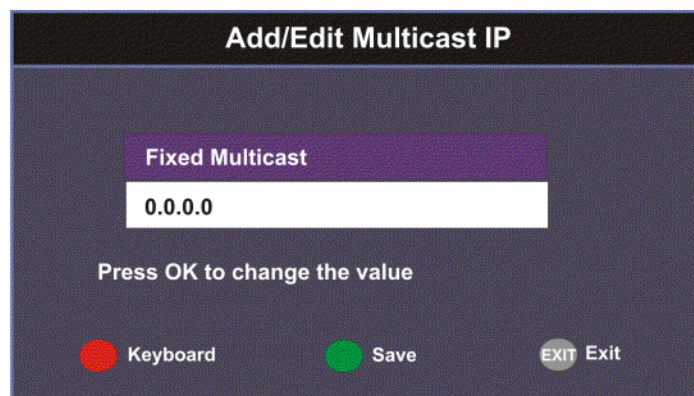

- Step 2** Set the multicast destination IP address, in the range from 0 to 255 for each of the four fields in the following format: ###.###.###.###. For example, 225.1.1.1.
- Step 3** Press the green button (**Save**) to save your changes.

Editing a Multicast IP Address

-
- Step 1** In the Multicast IP Setup screen, scroll to the multicast IP you want to edit using the ▼▲ buttons.
 - Step 2** Press **OK**. The Edit/Delete Multicast IP screen is displayed.
 - Step 3** Select **Edit** or press the blue button (**Edit**). The Add/Edit Multicast IP screen is displayed.
 - Step 4** Make the necessary changes.
 - Step 5** Press the green button (**Save**) to save your changes.
-

Deleting a Multicast IP Address

-
- Step 1** In the Multicast IP Setup screen, scroll to the multicast IP you want to delete using the ▼▲ buttons.
 - Step 2** Press **OK**. The Edit/Delete Multicast IP screen is displayed.
 - Step 3** Select **Delete** or press the red button (**Delete**). A message appears to confirm the deletion.
 - Step 4** Press **OK**.
-

Setting up SNMP

Proceed as follows to configure SNMP:

From the **Network Setup** screen, select **SNMP Setup** and press **OK**.

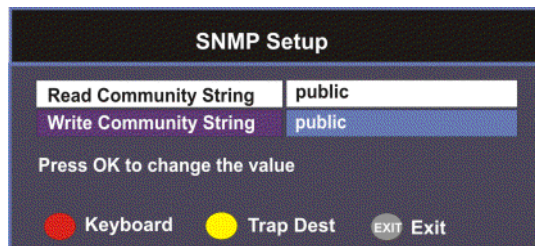

Set the **Read/Write Community String** to public or a custom string. The SNMP Community Read/Write is used when communicating with a device within an SNMP environment. These commands allow you to set the password to read and write data to a device to display diagnostics traps/alarms. The default community string is public. To set a custom community string, enter an alphanumeric character string up to 31-characters in length identifying the password for the device.



Note The community string is case-sensitive.

Viewing Trap Destinations



Note You can assign up to 10 entries to the Trap Destination and Community String fields.

Proceed as follows to view trap destinations:

From the **SNMP Setup** screen, press the yellow button (**Trap Dest**) to view trap destinations.

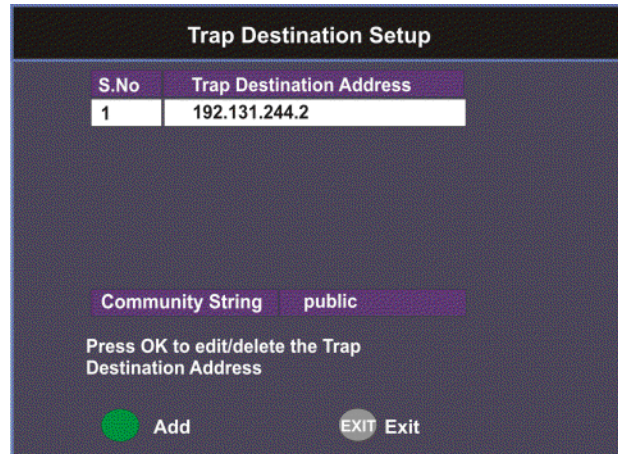

The **Trap Destination Setup** screen displays a list of trap destination addresses and the associated community string.

Adding Trap Destinations

Proceed as follows to add trap destinations:

- Step 1** From the **Trap Destination Setup** screen, press the green button (**Add**) to add a trap destination address.

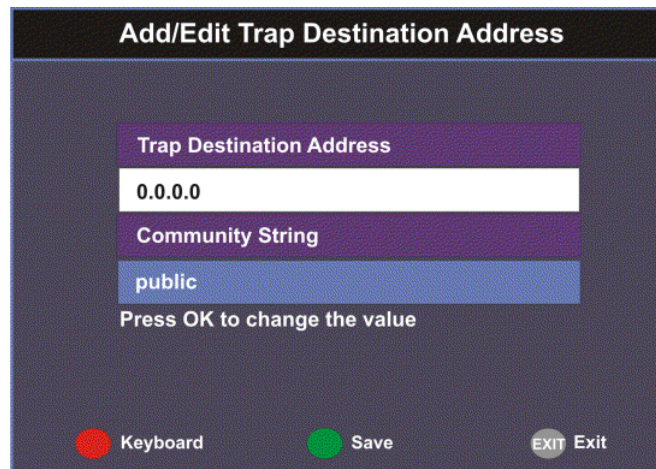

- Step 2** The following table describes each of the available options:

Selection	Options	Description
Trap Destination Address	Up to 12 digits in length (e.g., 155.128.100.200)	Enter the destination for SNMP trap messages for events (i.e., fault messages).
Community String	public or custom string. Up to 31 characters.	Set the community string for the trap IP address above. The default is public.

- Step 3** Click the green button (**Save**) to save the changes.

Editing/Deleting Trap Destinations

Proceed as follows to edit/delete trap destinations.

- Step 1** In the Trap Destination Setup screen, select the trap destination address you want to edit or delete and press **OK**.
- Step 2** Press the blue button (**Edit**) to edit the address. Press the red button (**Delete**) to remove the address from the Trap Destination list.
- Step 3** If you pressed the blue button, you can edit the Trap Destination Address and Community String and press the green button (**Save**) to save your changes.
- Step 4** If you pressed the red button (**Delete**), a warning message appears. Press **OK** to delete the selected trap destination entry. Otherwise, press **Exit**.

Configuring Noise Cutoffs

The Noise Cutoffs screen allows you to set the muting thresholds for both audio and video in the event of a noisy signal.

Proceed as follows to configure the noise cutoffs:

- Step 1** From the **Advanced Setup** screen, select **Noise Cutoffs** and press **OK**. A message appears confirming that you want to edit the noise cutoffs.
- Step 2** Select **Yes** to edit. Otherwise, select **No**.

Noise Cutoffs		
Noise Cutoffs	Enable	
DVB-S TS Mute	0.0	dB
DVB-S TS Restore	0.1	dB
DVB-S Audio Mute	0.0	dB
DVB-S Audio Restore	0.1	dB
DVB-S2 TS Mute	0.0	dB
DVB-S2 TS Restore	0.1	dB
DVB-S2 Audio Mute	0.0	dB
DVB-S2 Audio Restore	0.1	dB

Press OK to change the value

● Keyboard
 ● Save
 ● Default
 EXIT Exit

- Step 3** The following table describes each of the options:

Selection	Options	Description	Default
Noise Cutoffs	Enable or Disable	Sets whether to enable or disable the noise cutoffs functionality.	Enable
DVB-S/DVB-S 2 TS Mute	-5.0 to 20.0 dB	<p>This sets how the receiver reacts when the signal quality is severely degraded when using DVB-S or DVB-S2 modulation. This allows you to set the transport C/N margin values for the receiver. The receiver uses these noise values/settings as limits during normal operation to determine whether to mute the transport in the event of a noisy signal, poor signal or no signal condition.</p> <p>The mute is the lower limit for the transport C/N margin setting. The transport will be muted when the C/N margin is below the cutoff setting for a nominal delay of 1 second. The delay is between the time the condition is first detected and the time the transport is muted.</p>	0.0
DVB-S/DVB-S 2 TS Restore	5.0 to 20.0 dB	<p>This sets how the receiver reacts when the signal quality is severely degraded when using DVB-S or DVB-S2 modulation. This allows you to set the transport C/N margin values for the receiver. The receiver uses these noise values/settings as limits during normal operation to determine whether to mute the transport in the event of a noisy signal, poor signal or no signal condition.</p> <p>This is the upper limit for the transport C/N margin setting. The transport will be un-muted (e.g., restored) when the C/N margin rises above the Restore setting for a nominal delay of 8 seconds. The delay is between the time the condition is first detected and the time the transport is restored.</p>	0.1

Selection	Options	Description	Default
DVB-S/DVB-S 2 Audio Mute	5.0 to 20.0 dB	This is used to set the Audio channel Cutoff and Restore C/N margin values (limits) to mute audio when the signal quality is severely degraded when using DVB-S or DVB-S2 modulation. The Cut Off is the lower limit for the audio C/N margin setting. Audio will be muted when the C/N margin is below the Cutoff setting for a nominal delay of 4 seconds. The delay is between the time the condition is first detected and the time the transport is muted.	0.0
DVB-S/DVB-S 2 Audio Restore	5.0 to 20.0 dB	This is used to set the Audio channel Cutoff and Restore C/N margin values (limits) to mute audio when the signal quality is severely degraded when using DVB-S or DVB-S2 modulation. The Restore is the upper limit for the audio C/N margin setting. Audio will be un-muted (e.g., restored) when the C/N margin rises above the Restore setting for a nominal delay of 8 seconds. The delay is between the time the condition is first detected and the time the transport is restored.	0.1

The following displays the transport and audio default C/N Margin relationships:

Figure 4-2 Transport Default C/N Margin Relationship

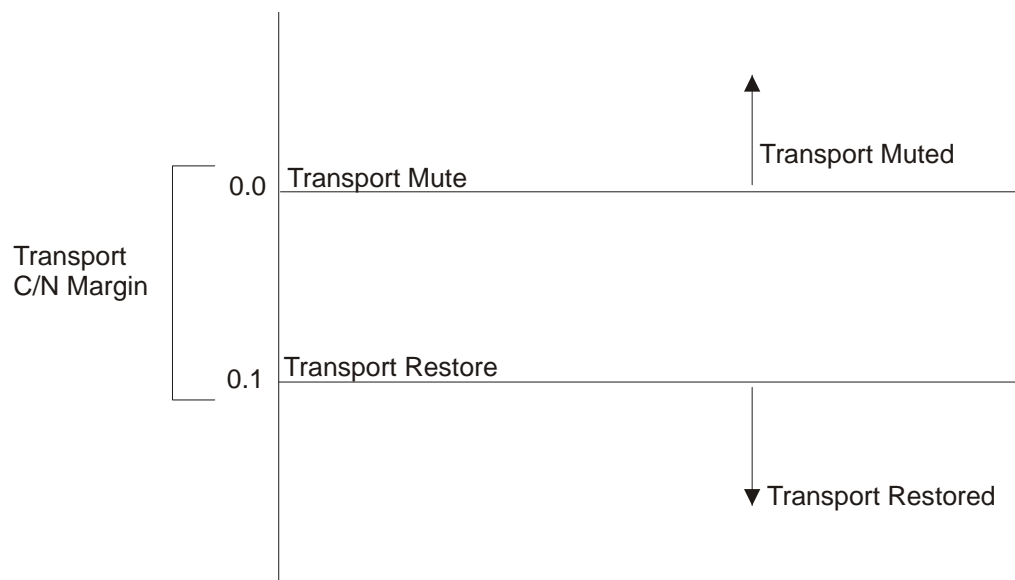
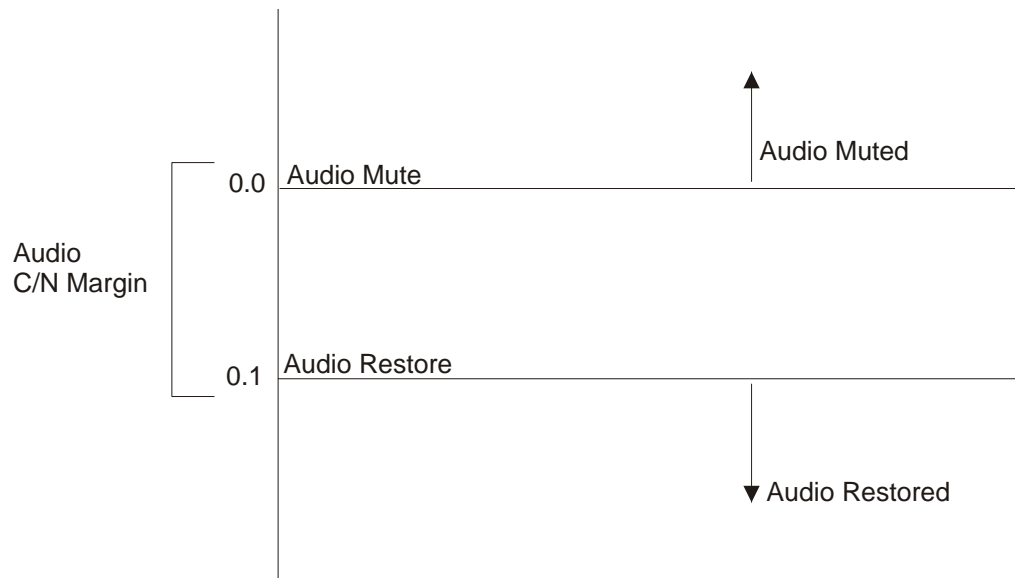

Figure 4-3 Audio Default C/N Margin Relationship



- Step 4** If you want to restore the transport stream and audio C/N margin options to their factory set (default) values, press the blue button (**Default**). A message appears confirming to restore to default values. Press **OK** to confirm.
- Step 5** Press the green button (**Save**) to save and apply the settings to the receiver.

Setting up Alarms and Warnings

Proceed as follows to set up the alarms and warnings:

- Step 1** From the Advanced Setup screen, select **Alarms & Warnings** and press **OK**.

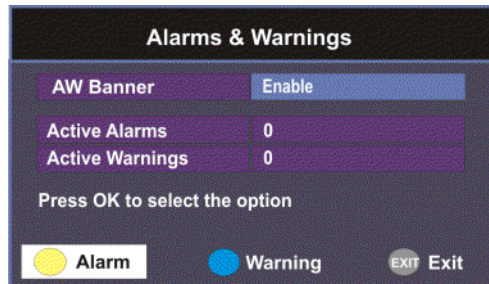

- Step 2** Set whether alarms and warnings are to be displayed on-screen in **AW Banner** (Enable or Disable).



Note The alarms and warnings will only appear on-screen if the screen is displaying video only. The AW Banner will not appear if EPG, Channel Banner or on-screen menus are displayed.

- Step 3** The **Active Alarms** displays the number of currently active Alarms, and the **Active Warnings** indicates the number of currently active Warnings.

- Step 4** Press the yellow button (**Alarm**) to configure the alarm settings. Press the blue button (**Warning**) to configure the warning settings.

To configure the Alarm settings

From the **Alarms & Warnings** screen, press the yellow button (**Alarm**) on the remote control.

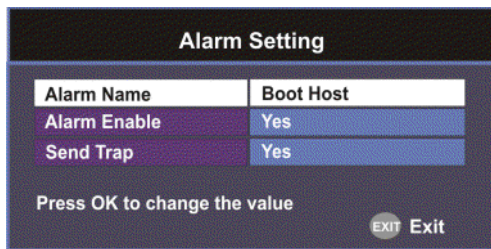

Set the following alarm options:

Alarm Setting	Description
Alarm Name	Displays a list of the alarm/fault messages. You can scroll through the list using the ◀▶ buttons.
Alarm Enable	When set to Yes , the alarm message will be reported. When set to No , the fault will not be reported.
Send Trap (D9865D only)	When set to Yes , the SNMP trap message will be sent to the trap destination; otherwise the fault message will be ignored.

To configure the Warning settings

From the **Alarms & Warnings** screen, press the blue button (**Warning**) on the remote control.

Set the following warning options:

Warning Setting	Description
Warning Name	Displays a list of the warning messages. You can scroll through the list using the ◀▶ buttons.
Warning Enable	When set to Yes , the warning message will be reported. When set to No , the fault won't be reported.
Send Trap (D9865D only)	When set to Yes , the SNMP trap message will be sent to the trap destination; otherwise the warning message will be ignored.

Performing Over-the-Air Downloads

Over-the-air downloads are controlled by the uplink. The **DL Mode** affects unforced over-the-air downloads. This feature is set to **Always** so that the uplink performs downloads to the receiver when necessary. The **Restart DL** forces over-the-air downloads. Use this feature if you want to control over-the-air downloads at the receiver or restart a download due to signal interruption. The **Abort DL** aborts the download at any time.

To configure and/or restart an over-the-air download:

- Step 1** From the **Advanced Setup** screen, select **Download** and press **OK**.

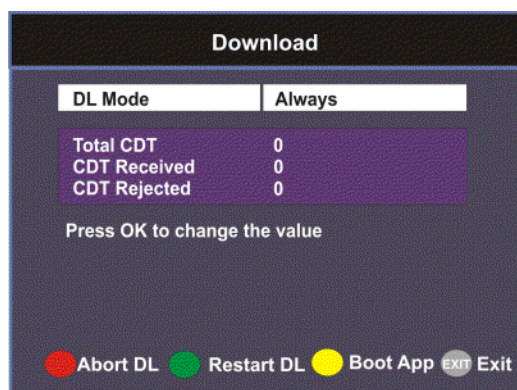

- Step 2** Select the **DL Mode**. The options are Always, Once, or Never. The **DL Mode** only affects unforced over-the-air downloads. This feature is set to **Always** for normal operation.

DL Mode Setting	Description
Always	<p>Normal (default) setting for everyday operation. Downloads are performed as necessary by the uplink. After the download is completed, the unit will not reboot.</p> <p>If an unforced download is in progress and you change the DL Mode from Always to Never, the download will abort.</p> <p>If an unforced download is in progress and you change the DL Mode from Always to Once, the download will restart.</p>
Once	<p>Use this setting if you want to perform a download once only. After the download is completed, the unit will reboot and the state changes to Never.</p> <p>If an unforced download is in progress and you change the DL Mode from Once to Never, the download will abort.</p> <p>If an unforced download is in progress and you change the DL Mode from Once to Always, the download will restart.</p>
Never	<p>Use only when downloads are not required.</p> <p>If an unforced download is in progress and you change the DL Mode from Never to Always or Once, the download will start.</p>

- Step 3** Press **OK** to save the DL mode changes.

- Step 4** Press the green button (**Restart DL**) to force an over-the-air download. You can press the red button (**Abort DL**) at any time to abort the download operation. Once the download is complete, the receiver reboots. Following reboot, the receiver returns to the last viewed channels.

Setting Bootable Application Selection

To View Application Version numbers

Proceed as follows to view the application version numbers:

From the Download screen, press the yellow button (**Boot App**).

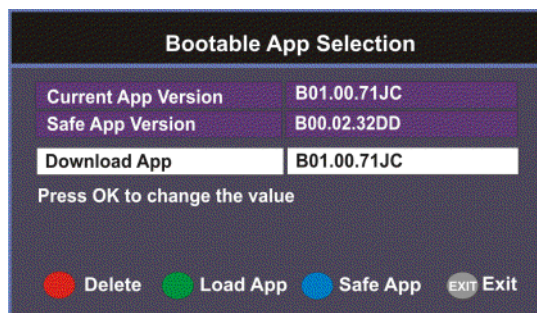

The **Current App Version** displays the currently running loaded application version number. The **Safe App Version** displays the factory loaded application version number.

To Change the Download Application

The Download App field allows you to select a different application version application to load to your receiver. Press the green button (**Load App**) to load the selected application version and reboot the receiver.

Press the blue button (**Safe App**) to reboot the receiver and load the factory installed application version.

Press the red button (**Delete**) to remove the selected application version. You will be prompted to continue or not. Press **OK** to continue the deletion.

Viewing System Information

Proceed as follows to view the System Information screen.

From the **Setup Menu** screen, select **Info** and press **OK**.

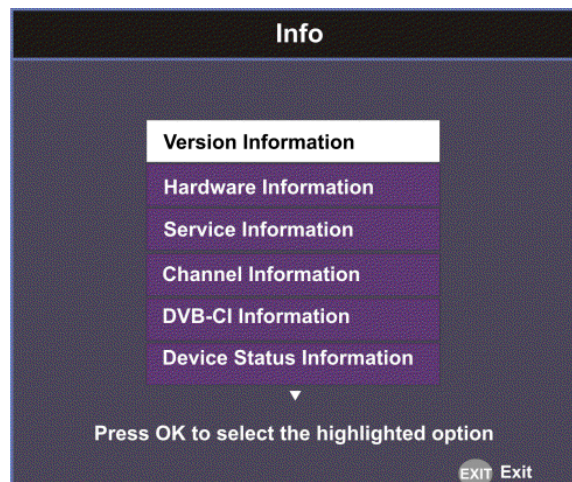

The function for the available sub-menus is as follows:

- Version
 - This menu displays the current and factory loaded application version numbers.
- Hardware
 - From this menu, it provides the D9865 receiver's hardware information.
- Service
 - This menu displays the channel service information.
- Channel
 - This menu displays the current channel information.
- DVB-CI
 - This menu displays the CAM (Conditional Access Module) Smart Card information for the CI (Common Interface) slot.
- Device Status
 - This menu displays the status of the D9865 receiver.
- Active Alarm
 - This menu lists all the active alarm messages.
- Active Warning
 - This menu lists all the active warning messages.
- RF Status
 - From this menu, it displays the RF input status.
- ADP Status
 - This menu displays the Encrypted and Non-encrypted Addressed Data Packet Count information.

Viewing the Version Information

Proceed as follows to view the version information.

From the **Info** screen, select **Version Information** and press **OK**.

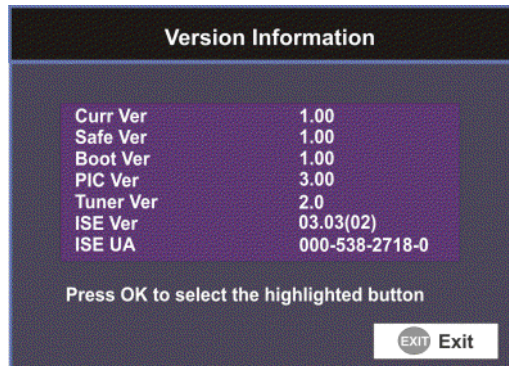

The following table displays the version information:

Version Information	Description
Curr Ver	Indicates the currently running loaded application version number.
Safe Ver	Indicates the factory loaded application version number.
Boot Ver	Indicates the receiver Boot application version number.
PIC Ver	Indicates the Programmable Interrupt Controller (PIC) version number.
Tuner Ver	Indicates the version number of the tuner.
ISE Ver, ISE UA	Displays the ISE Version Number and ISE User Address.

Viewing Hardware Information

Proceed as follows to view the hardware information.

From the **Info** screen, select **Hardware Information** and press **OK**.

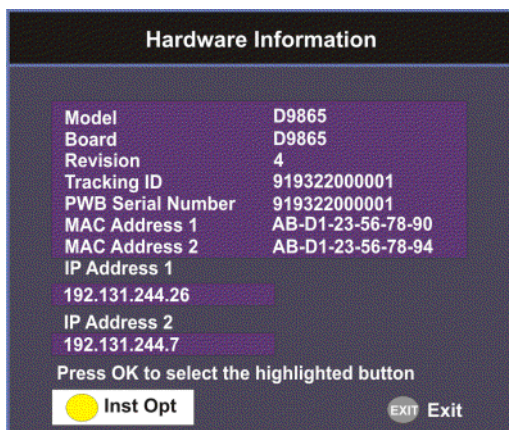

The following table displays the hardware information:

Hardware Information	Description
Model	Indicates the model number of the receiver.
Board	Indicates the board type.
Revision	Indicates the board revision number.
Tracking ID	This is the unique Tracking ID number that identifies the product version.
PWB Serial Number	Displays the serial number for the PWB (printed wiring board).
MAC Address 1, MAC Address 2 (D9865D only)	Indicates the MAC addresses assigned to the Ethernet interface at the time of manufacture.
IP Address 1 and IP Address 2 (D9865D only)	Indicates the IP address assigned to the receiver in a network for Port 1 and Port 2.
	 Note Only Port 1 is available for this release.

Viewing Installed Options

Proceed as follows to view the installed hardware options:

From the Hardware Information screen, press the yellow button (**Inst Opt**).

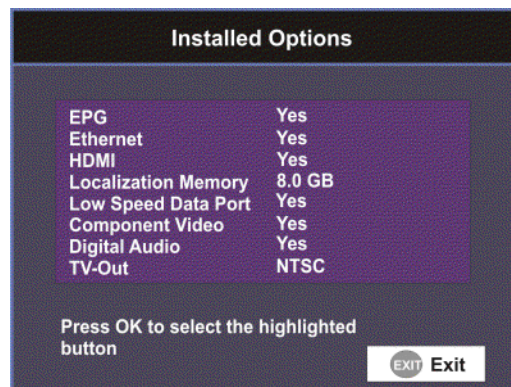

The Installed Options screen displays the hardware options installed in the current D9865 satellite receiver.

Viewing Service Information

Proceed as follows to view the service information.

From the **Info** screen, select **Service Information** and press **OK**.

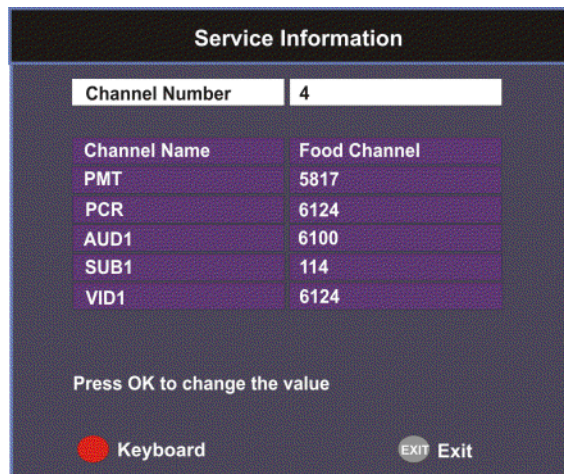

The Service Information screen displays the PIDs associated with a selected channel.

About Subscriber Services

Subscriber uplink services made available to your satellite receiver are associated with virtual channels. These channels can include video, audio, and/or data services. All authorized virtual channel services are provided via PowerVu Network Centre (PNC) system software and broadcast facility equipment, and are decoded by the receiver. You can view available subscriber services for any received virtual received channel on this menu and tune to the selected channel by entering the particular **Channel Number**.

About the Current Channel

When you navigate to menus from video, the information displayed is associated with the current (video) channel. If no changes have been made to the current setup, you can automatically return to the same channel when you exit to video.

Viewing Channel Information

Proceed as follows to view the Channel Information screen:

From the **Info** screen, select **Channel Information** and press **OK**.



The Channel Information screen displays the following information:

Channel Information	Description
Channel Number	Current channel number. To change the current channel number, press OK. Enter the number using the keypad on the remote control and click OK. It tunes to the selected channel.
Channel Name	Current channel name associated with the channel number.
Last Activated Preset	Indicates the number of the last activated preset.
CA Authorized	Indicates whether the receiver is authorized to receive the signal.
CA Id	Indicates the identification number of the CA used for the received signal.
CA Type	Indicates the type of CA used for the received signal.
CA Scrambled	Indicates whether the received signal is scrambled.
CA Encrypted	Indicates whether the received signal is encrypted.

Viewing DVB-CI Information

The Common Interface (CI) slot is located behind the door on the front panel. They allow use of a CAM (Conditional Access Module) Smartcard to decrypt purchased programming.



Note

You must be authorized to view the programming available via the Smart Card from your service provider.

CAMs must be purchased from Cisco. For a list of the supported CAMs, see [Common Interface Modules, page 3-4](#).

For more information on configuring the CI information, see [Configuring the Common Interface \(CI\) Information, page 5-21](#).

To View the Current DVB-CI Information

Proceed as follows to view the DVB-CI information:

From the **Info** screen, select **DVB-CI** and press **OK**.

DVB-CI Information		
CI System Name	AlphaCrypt	
CAM Manufacturer	SCM	
CAM Serial Number	Unknown	
CAM Product Name	DVB CA Module	
CAM Hardware Version	Unknown	
CAM Application Version	3.12	
CAM Status	Ready	
S.No	System Name	System ID
1	Irdeco	1542
2	Irdeco	1538
3	Irdeco	1540
Press OK to select the highlighted button		
		EXIT Exit

The DVB-CI Information screen displays the following information:

DVB-CI Information	Description
CI System Name	Indicates the system name of the CAM.
CAM Manufacturer	Displays the manufacturer name of the CAM.
CAM Serial Number	Indicates the unique serial number of the CAM.
CAM Product Name	Displays the product name of the CAM.
CAM Hardware Version	Displays the hardware version number of the CAM.
CAM Application Version	Displays the software version number of the CAM.
CAM Status	Displays the status of the CAM (Ready or Not Ready).
S.No/System Name/System ID	Displays the CA system identification number and name of the CAM. Some CAMs may support multiple CA system IDs.

Viewing Device Status Information

Proceed as follows to view the device status information:

From the **Info** screen, select **Device Status** and press **OK**.

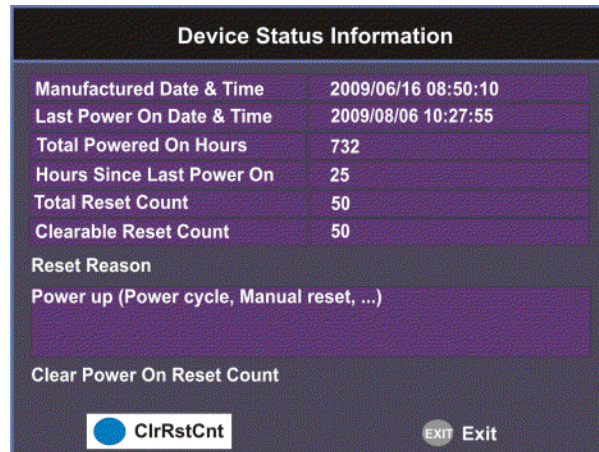

The Device Status Information screen displays the following information:

Device Status Information	Description
Manufactured Date & Time	Displays the date and time when the receiver was manufactured.
Last Power On Date & Time	Displays the date and time when the receiver was powered up.
Total Powered On Hours	Displays the total number of hours that the receiver has been operating.
Hours Since Last Power On	Displays the number of hours since the last power-on.
Total Reset Count	Displays the total number of times the receiver has been restarted.
Clearable Reset Count	Displays the number of restarts since the last time the restart count was cleared. To clear or reset the Clearable Reset Count, press the blue button (ClrRstCnt).
Reset Reason	Displays the reason for the last restart, i.e., power cycle or manual reset.

Viewing the Active Alarm and Warning Messages

To View the Active Alarm Messages

Proceed as follows to view the active alarms:

From the **Info** screen, select **Active Alarm** and press **OK**.

Active Alarm	
Name of Alarm	Set Since
Signal Status	2009/12/23 18:09:39
LNB PS	2009/12/23 18:09:34
Signal Status	2009/12/23 19:11:20

Details:

Tuning Parameters Invalid

Press Up/Down to scroll in the list.

EXIT Exit

The Active Alarm screen displays all the active alarm messages for the D9865 system.

The following table shows the alarm status table information:

Active Alarm Information	Description
Name of Alarm	Name of the alarm. For more information on alarm messages, refer to Alarm Messages, page 6-1 .
Set Since	Date and time of the alarm.
Details	Displays the content of the message.

To View the Active Warning Messages

Proceed as follows to view the active warnings:

From the **Info** screen, select **Active Warning** and press **OK**.

Active Warning	
Name of Warning	Set Since
Transport Error	2009/12/23 18:09:45
VBI Data	2009/12/23 18:09:47
ETH Port 2 Link Down	2009/12/23 18:09:49

Details:

ETH Port 2 Link Down

Press Up/Down to scroll the list

EXIT Exit

The Active Warning screen displays all the active warning messages for the D9865 system.

The following table shows the warning status table information:

Active Warning Information	Description
Name of Warning	Name of the warning. For more information on warning messages, refer to Warning Messages, page 6-10 .
Set Since	Date and time of the warning.
Details	Displays the content of the message.

Viewing the RF Status

Proceed as follows to view the RF status:

From the **Info** screen, select **RF Status** and press **OK**.

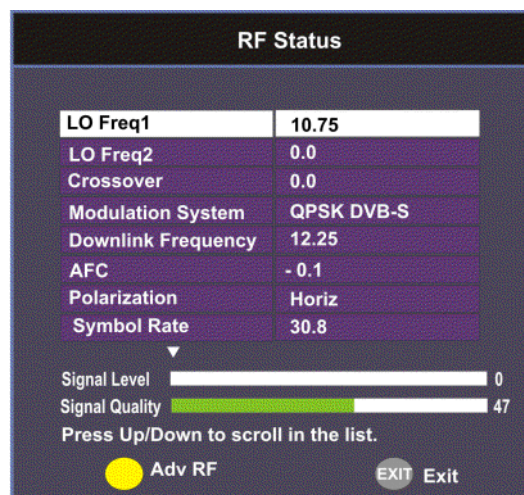

The following table describes the RF Status information displayed:

RF Status	Description
Downlink Frequency	Indicates the current downlink frequency, in GHz.
Symbol Rate	Indicates the Symbol Rate of the received signal, in MS/s.
Polarization	Indicates the signal polarization setting. This setting is only applicable when LNB Power is set to H-NIT or V-NIT. The selected setting must match the polarization of the transmitted signal.
FEC	Indicates the FEC (Forward Error Correction) rate of the received signal.
LO Freq 1/2	Displays the Local Oscillator frequency #1 and #2.
Crossover	Indicates the crossover frequency, which is an internal threshold frequency used for selecting the LO1 or LO2 frequency, depending on the current Downlink frequency setting. This is only used in Ku-Band dual LNB application.
AFC	Indicates the current Automatic Frequency Control adjustment, in MHz.
Modulation System	Indicates the modulation type of the received signal.

RF Status	Description
PV BER	Indicates the PV (Post-Viterbi) BER of the received signal (DVB-S only).
LDPC BER	Indicates the LDPC (Low-Density Parity-Check) error rate of the selected input (DVB-S2 only).
PER	Indicates the current PER (Packet Error Rate).
C/N Margin	Indicates the current Carrier-to-Noise Margin of the received signal, in dB. The Carrier-to-Noise margin is the actual distance that C/N is from the noise threshold.
Signal Lock	Indicates the current signal lock status for the input.
Rolloff Mode	Indicates the rolloff mode of the incoming signal. The default is set to Auto.
Rolloff Factor	Indicates the rolloff factor of the incoming signal.
LNB PS Status	Indicates the current LNB connection status (No Load, Overloaded, OverTemp, Short Circuit, Disabled, Normal, or N/A).

Signal Level and Signal Quality

The **Signal Level** and **Signal Quality** of the incoming signal are displayed both numerically and graphically using bar graphs.

The Signal Level is associated with the RF input signal level. The Signal Level display is continuously updated to indicate the relative strength of the received RF input signal. It is displayed in the range from 0 to 100.

The Signal Quality is associated with the Bit Error Rate (displayed in the range from 0 to 100). The Signal Quality is continuously updated to indicate the relative quality of the received RF input signal.

Viewing Advanced RF Diagnostics

The Advanced RF diagnostics screen is primarily used by Cisco customer support for information purposes only, if needed.

Proceed as follows to view the Advanced RF Diagnostics screen:

From the **RF Status** screen, press the blue button (**Adv RF**).

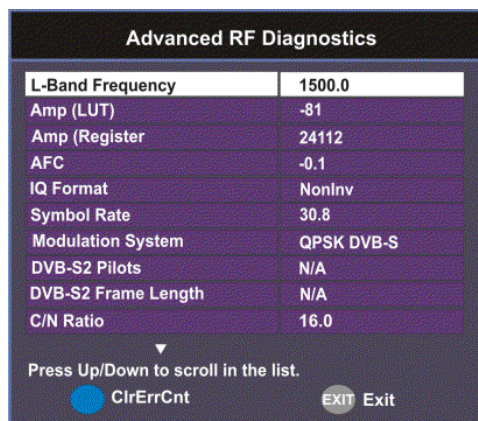

Press the blue button (**ClrErrCnt**) to clear the error counters.

Viewing ADP Status

Proceed as follows to view the ADP Status screen.

From the **Info** screen, select **ADP Status** and press **OK**.

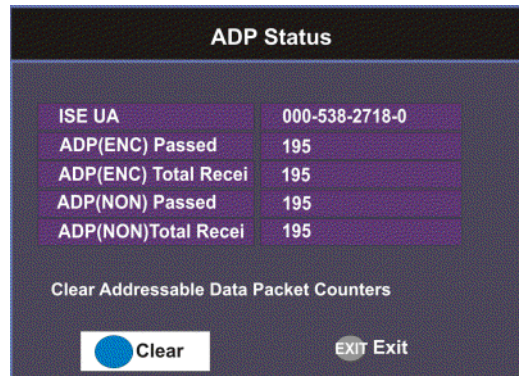

The following table describes the ADP status information displayed:

ADP Status	Description
ISE UA	Indicates the ISE user address (11 decimal characters).
ADP(ENC) Passed	Indicates the current Encrypted Addressed Data Packet Count. This count indicates the amount of transmitted ADP information being accurately received and processed. Ideally, the ADP(ENC) Passed and ADP(ENC) Total Received numbers should be identical.
ADP(ENC) Total Received	Indicates the total Encrypted Addressed Data Packet Count. This count indicates the amount of transmitted ADP information being accurately received and processed. Ideally, the ADP(ENC) Passed and ADP(ENC) Total Received numbers should be identical.
ADP(NON) Passed	Indicates the current Non-Encrypted Addressed Data Packet count. This count indicates the amount of transmitted ADP information being accurately received and processed. Ideally, the ADP(NON) Passed and ADP(NON) Total Received numbers should be identical.
ADP(NON) Total Received	Indicates the total Non-Encrypted Addressed Data Packet count. This count indicates the amount of transmitted ADP information being accurately received and processed. Ideally, the ADP(NON) Passed and ADP(NON) Total Received numbers should be identical.

Press the blue button (**Clear**) to clear the total numbers above. To help the operator make accurate analysis of the receiver's functionality, the ADP(ENC) and ADP(NON) numbers should be cleared. These same values are also reset whenever the receiver is turned on, reset, or power-cycled.



CHAPTER 5

Setup and Monitoring via Web GUI

This chapter describes how to set up and monitor the D9865 Satellite Receiver using the web GUI. This chapter presents the following major topics:

- [Logging on to the Web GUI, page 5-2](#)
- [Overview of the Main D9865 Settings, page 5-3](#)
- [Setting up Tuning Information, page 5-8](#)
- [Setting Up Dish Pointing, page 5-10](#)
- [Setting up the Tuning Presets/LNB, page 5-17](#)
- [Viewing Input Status, page 5-19](#)
- [Setting the Channel Information, page 5-20](#)
- [Configuring the Common Interface \(CI\) Information, page 5-21](#)
- [Viewing the PSI Tables, page 5-24](#)
- [Viewing PSI Frequency Information, page 5-25](#)
- [Viewing the PSI Channels, page 5-27](#)
- [Setting up the Video, page 5-28](#)
- [Viewing System Information, page 5-33](#)
- [Setting Up IP Information, page 5-35](#)
- [Configuring Time/Clock Information, page 5-38](#)
- [Configuring Favorites and Reminders, page 5-39](#)
- [Viewing the Alarm/Warning Status, page 5-41](#)
- [Viewing the Alarm/Warning History, page 5-44](#)
- [Viewing Version Information, page 5-45](#)
- [Setting Up Import/Export Information, page 5-46](#)
- [Viewing the Backup/Restore History, page 5-47](#)
- [Managing D9865 Web GUI Accounts, page 5-48](#)
- [Configuring Lock Level Settings, page 5-51](#)
- [Viewing Contact Information, page 5-53](#)
- [Viewing Diagnostic Logs, page 5-53](#)
- [Viewing the Usage Counters, page 5-54](#)

- [Performing Service Actions, page 5-55](#)

Logging on to the Web GUI

Proceed as follows to log on to the Web GUI:

-
- Step 1** Open MS Internet Explorer.
- Step 2** Type the IP address of the D9865 Satellite Receiver in the address bar and press **Enter**.

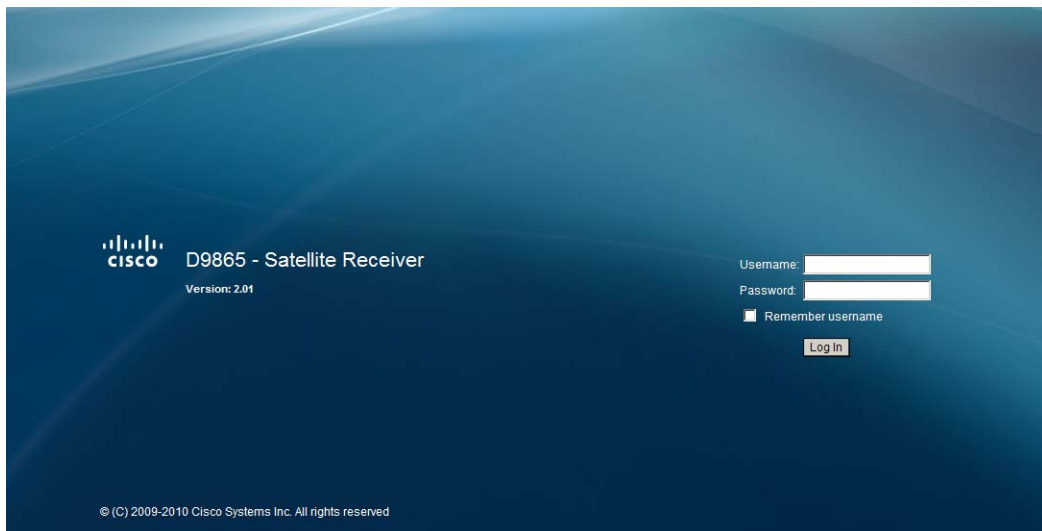

- Step 3** Type the **Username** and **Password**.

The username and password are case-sensitive. The default username is **admin** and the default password is **localadmin**. If you have forgotten your username and password, you can reset them to its factory defaults from the on-screen menu of the D9865 Satellite Receiver. For more information, refer to [Viewing System Information, page 4-57](#).



Tip The password and user name will be remembered for the whole web session. Close the web browser if you want to prevent others from accessing the settings of the D9865 Satellite Receiver.

If your session expires, you must refresh the browser and log back in.

- Step 4** Click **Log In**.



Note If you select **Remember username**, the user name will be remembered the next time you log into the web GUI.

Overview of the Main D9865 Settings

Proceed as follows to get an overview of the main D9865 Satellite Receiver settings:

- Step 1** Log on to the Web GUI.
- Step 2** Click **Summary > Summary Dashboard**. The Summary Dashboard page is displayed.

The screenshot shows the Cisco D9865 - Satellite Receiver web interface. At the top, there is a navigation bar with 'Summary' selected, and other options like 'Input', 'Audio & Video', 'System Settings', and 'Support'. Below this, the 'Summary Dashboard' is displayed, featuring several status sections: 'Decoded Program Status', 'Audio Status', 'Current Input Status', 'Tuner Performance', 'Video Status', and 'Channel Status'. Each section has a title bar with minimize, maximize, and close buttons. Annotations with arrows point to these buttons, with labels like 'Buttons - click to open the specific setup pages.' pointing to the top navigation bar, 'Mini-maximize/Maximize' pointing to the window control buttons of the 'Decoded Program Status' section, and 'Close Section' pointing to the close button of the same section.

The summary screen displays the main settings of the D9865 Satellite Receiver.

The buttons above the sections in the Summary Dashboard are shortcuts to the various setup pages. For example, click **Tuning Setup** to open the Tuning Setup page.

You can customize the Summary Dashboard by temporarily minimizing or removing the modules displayed. Each module has a maximize and minimize button, allowing you to view or hide various modules. The default view is displayed when you refresh the Summary Dashboard page.

You can also customize the Dashboard by clicking on **Add/Remove Module**. The Dashboard Configuration window is displayed.

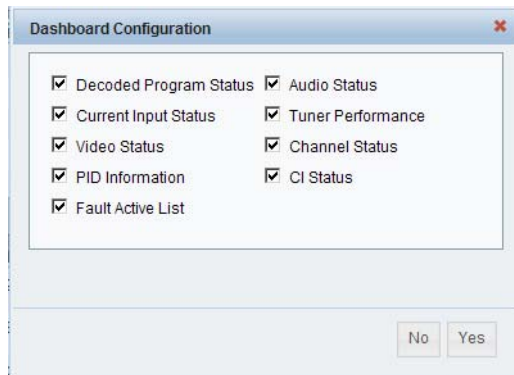

The following table describes the all the available modules:

Module	Description
Decoded Program Status	Displays channel and service information.
Audio Status	Displays the current audio status information, such as the audio format and sampling frequency.
Current Input Status	Displays the current RF Tuning Status information, including the downlink frequency and signal status.
Tuner Performance	Displays the satellite dish status, such as the C/N Margin and Signal Level.
Video Status	Displays the current video information.
Channel Status	Displays the channel status information, such as the type of CA used and whether the receiver is authorized to receive the signal.
PID Information	Displays the PIDs associated with the channels.
CI Status	Displays the CAM card information.
Fault Active List	Displays the currently active alarms and warnings.

Linked Pages

The GUI of the D9865 has a number of linked pages.



The function for the linked pages is as follows:

- Summary
 - From this page you can obtain an overview of the D9865 operation.
- Input

From this page you can:

 - set presets and LNB,
 - configure dish pointing/alignment,
 - view input status,
 - configure channels,
 - configure CI (Common Interface) settings,
 - view PSI, Frequency, and Channel tables.
- Audio & Video

From this page you can:

 - configure video settings,
 - set up closed caption and subtitles,
 - configure audio settings,
 - view current audio status.
- System Settings

From this page you can:

 - view alarm and warning status information
 - configure ethernet ports,
 - configure lock levels.
- Support

From this page you can:

 - view logs,
 - view contact information
 - View and upgrade software version.

D9865 Web GUI Environment

The following is an example of a D9865 Web GUI page.

The screenshot shows the Cisco D9865 Web GUI interface. The top navigation bar includes 'Summary', 'Input', 'Audio & Video', 'System Settings', and 'Support'. The left sidebar shows a tree view with 'Satellite' expanded to 'Tuning Setup'. The main content area is titled 'Tuning Setup' and contains several configuration fields: Downlink Frequency (11.25 GHz), Symbol Rate (30.8 Msym), Modulation Type (DVB-S2), I/Q (Auto), 22 KHz Control (Off), LNB Power (18-H), Network ID (1), LO Freq 1 (9.75 GHz), LO Freq 2 (0.0 GHz), and Crossover Frequency (0.0 GHz). Below these fields is a 'Current Input Status' table. At the bottom are 'Apply' and 'Refresh' buttons. Annotations with arrows point to various elements: 'Icons' to the left menu, 'Links' to the top bar, an information icon with text 'Displays as you edit the page. Changes are applied on the receiver only (not on the uplink). Click Apply to save the changes.', a red asterisk on the Symbol Rate field with text 'Indicates a mandatory field.', and the 'Apply' and 'Refresh' buttons with text 'Buttons'.

The Window Buttons

The GUI of the D9865 has the following general buttons:

Button	Description
Apply	Saves and applies the settings to the receiver. If you make changes on a web page, ensure that you apply the changes before moving to another page. If you move to another page without saving your (edits) changes, the web GUI will revert to the previously saved settings, and the changes will be lost. Also, ensure that you save all changes on a web page before leaving your PC; otherwise, the GUI will eventually time out and revert back to the previously saved settings.
Refresh	Reads existing data from the D9865. If edits were made in a setup page, then unsaved changes are discarded.

The About Window

The top right hand corner of the D9865 web GUI has an About link. Click to open the About window.



The About window displays the current D9865 system version information and the copyright information.

Setting up Tuning Information

Proceed as follows to configure the Tuning Setup page:

- Step 1** From the user interface of the D9865, click **Input > Satellite > Tuning Setup**. The Tuning Setup page is displayed.

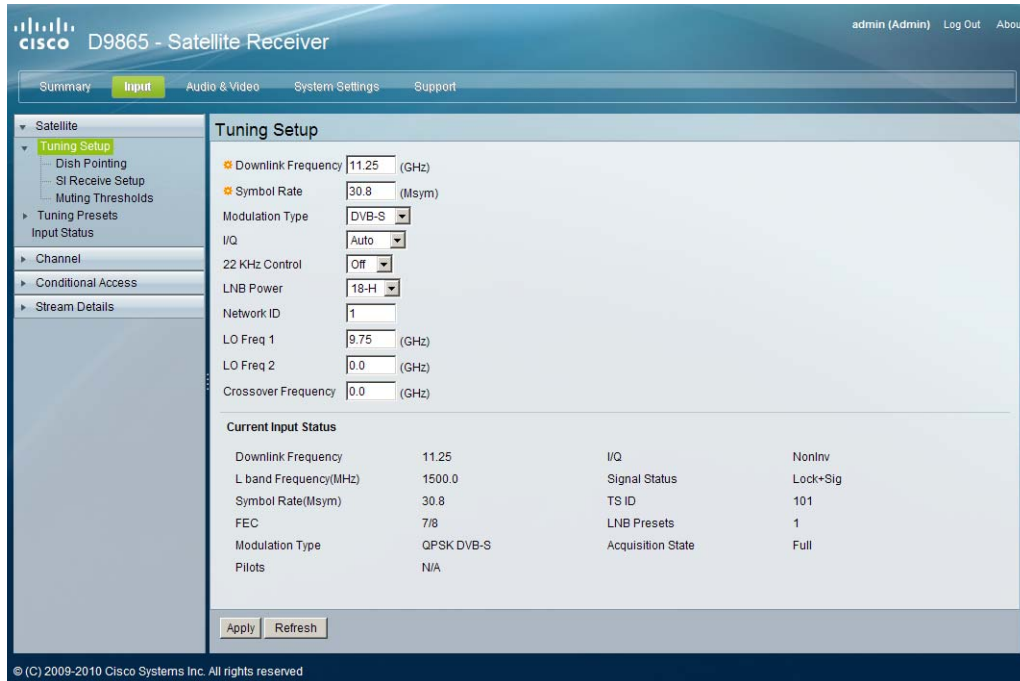

- Step 2** Set the **Downlink Frequency** used by the receiver for tuning the received digital signal. You can enter a value in the range from 0.0 to 15.0 GHz. The formula for C-Band is: Downlink Freq = LO Freq - L-Band Freq. The formula for Ku-Band is Downlink Freq = LO Freq + L-Band Freq.
- Step 3** Type the Symbol Rate. The symbol rate must match that of transmitted signal. You can enter a value in the range from 1.0 to 45.0 MS/s for DVB-S or 1.0 to 31.0 MS/s for DVB-S2.
- Step 4** Select the **Modulation Type** for the received signal (DVB-S or DVB-S2).
- Step 5** Set the input signal spectrum inversion setting (**I/Q**), which allows the operator to track and selected inverted or non-inverted digital signals.
- When set to Auto, received digital signals are tracked and inverted for correct selection, as required. When set to Inv (inverted), the received digital signal is always inverted. Conversely, when set to NonInv (non-inverted), the received digital signal is never inverted.
- Step 6** The **22 KHz Control** is only applicable for dual-band LNB applications. It sets whether or not the 22 KHz tone is available. The selections are On, Off, or Auto (if downlink frequency is greater/less than the crossover frequency, the 22KHz tone is automatically set to on/off). The default is Off.
- Step 7** The LNB Power setting determines if power is provided via the input to an external LNB connection. You can set the LNB Power to Off, 18-H, 13-V, H-NIT, or V-NIT. The default is 18-H. If LNB Power is set to V-NIT or H-NIT, the signal polarization is automatically read from the NIT. Power will not be applied to the LNB if LNB Power is set to Off.



Note LNB power must be on if DiSEqC is required. For more information, see [LNB Power Settings](#), page 4-21.

- Step 8** Enter the **Network ID** of the uplink signal the receiver is to receive when using this preset. You can obtain the network ID from your service provider. The default is 1.
- Step 9** Set the Local Oscillator Frequency #1 (**LO Freq 1**), which sets the satellite antenna LNB local oscillator #1 frequency. For C-Band application, set to 5.15 GHz. For Ku-band single LNB, enter LO Freq and set LO Freq 2 and Crossover Frequency to 0.0. For Ku-band dual LNB, enter LO Freq 1, LO Freq 2 and Crossover Frequency. The default is 10.75 GHz.
- Step 10** Set the Local Oscillator Frequency #2 (**LO Freq 2**), which sets the satellite antenna LNB local oscillator #2 frequency. This option is only used in dual-band LNB applications. LO Freq 2 must be greater than LO Freq 1. The default is 0.0 GHz.
- Step 11** Enter the **Crossover Frequency**. This is an internal threshold frequency used for selecting the LO1 or LO2 frequency, depending on the current downlink frequency settings. This option is only used in dual-band LNB applications. The default is 0.0 GHz.
- Step 12** The **Current Input Status** section displays the current RF status. The following table describes the Current Input Status information displayed:

RF Status	Description
Downlink Frequency	Indicates the current downlink frequency, in GHz.
L Band Frequency (MHz)	Indicates the current L-Band frequency, in MHz.
Symbol Rate (Msym)	Indicates the Symbol Rate of the received signal, in MS/s.
FEC	Indicates the FEC (Forward Error Correction) rate of the received signal.
Modulation Type	Indicates the modulation type for the received signal.
Pilots	Indicates whether the pilots for the DVB-S2 modulation is on or off.
I/Q	Indicates the input signal spectrum inversion setting.
Signal Status	Indicates the current signal lock status for the input. Locked - Receiver is locked to a carrier with no valid content. Lock+Sig - Receiver is locked to a carrier with valid content. No Lock - Receiver is not locked to a carrier.
TS ID	Displays the Transport Stream ID.
LNB Presets	Indicates the number of LNB presets configured.
Acquisition State	Displays Full if the ASI and PSI tables have all been found. Otherwise, it will display Degraded if there are missing tables or None if no ASI or PSI tables have been found.

- Step 13** Click **Apply**.

Setting Up Dish Pointing

The Dish Pointing page allows you to configure the satellite dish position. There are two modes: User Action (default) or Installer Action. The User Action mode allows you to select from stored Satellite Numbers, which are stored satellite locations, as stored in the dish motor, but does not provide any dish control.

Proceed as follows to set up the dish in User Action mode:

- Step 1** From the user interface of the D9865 Satellite Receiver, click **Input > Satellite**, expand **Tuning Setup** and then click **Dish Pointing**. The Dish Pointing page is displayed.

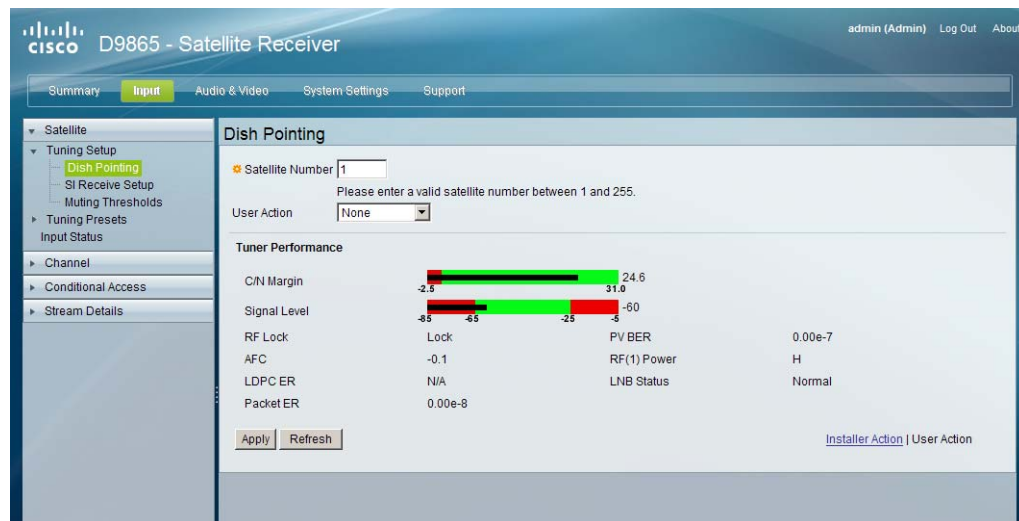

- Step 2** Enter the **Satellite Number** identifying the saved satellite location, as defined by the dish motor manufacturer. You can enter a value in the range from 1 to 255.
- Step 3** Select Goto Satellite as the **User Action** to move the dish to the selected pre-stored satellite position. Satellite positions are stored in the dish motor, if supported, not in the receiver. Select None if no action is performed.
- Step 4** The **Dish Status** section displays the current satellite dish information. The following table describes the satellite dish information displayed:

Parameter	Description
C/N Margin	Indicates the current Carrier-to-Noise Margin for the received signal. The Carrier-to-Noise margin is the actual distance that C/N is from the noise threshold.
Signal Level	Displays the relative strength of the received RF input signal. It is displayed in the range from 0 to 100.
RF Lock	Indicates whether the receiver is synchronized with the received RF signal.
AFC	Indicates the current Automatic Frequency Control adjustment, in MHz.

Parameter	Description
LDPC ER	Indicates the bit rate of the input stream of the LDPC error correction stage (DVB-S2 only).
Packet ER	Indicates the current Packet Error Rate.
PV BER	Indicates the PV (Post-Viterbi) BER for the received signal (DVB-S).
RF(1) Power	Displays the LNB Power setting. The LNB Power setting determines if power is provided via the RF1 Input to an external LNB connection.
LNB Status	Indicates the current LNB connection status (No Load, Overloaded, OverTemp, Short Circuit, Disabled, Normal, or N/A).

Step 5 Click **Apply**.

To set up the dish in Installer Action mode:

Proceed as follows to set up the dish in Installer Action mode:

Step 1 From the Dish Pointing page, click on the **Installer Action** link at the bottom right hand corner of the page.

Step 2 Enter the **Satellite Number** identifying the saved satellite location, as defined by the dish motor manufacturer. You can enter a value in the range from 1 to 255.

Step 3 Select the **Installer Action**. The following table describes the actions available:

Options	Description
Continuous West Movement	Moves the dish west until it reaches its limit. Ensure that the dish can move to its limit without any obstructions.
Continuous East Movement	Moves the dish east until it reaches its limit. Ensure that the dish can move to its limit without any obstructions.
Stop Move	Stops movement of the dish.
Goto Absolute Position West	Moves the dish to the Absolute west position set above.
Goto Absolute Position East	Moves the dish to the Absolute east position set above.
Goto Reference	Moves the dish to a reference defined by the dish motor manufacturer.
Goto Satellite	Moves the dish to the selected pre-stored satellite position. Satellite positions are stored in the dish motor, if supported, not in the receiver.
Store Satellite	Stores the current dish position as a Satellite Number, if supported by the dish motor.
Clear Limits	Clears the dish east and west limits stored in the dish motor.
Store East Limits	Stores the current position as the east limit in the dish motor.
Store West Limits	Stores the current position as the west limit in the dish motor.
Calculate Position	Updates the position of the dish according to the current position. For more information, refer to the dish manual provided by the dish manufacturer.
None	No action is performed.

Step 4 Enable or disable the Digital Satellite Equipment Satellite Control (**DiSEqC**).



Note This must be enabled to control the DiSEqC switch. LNB Power must be on to use this setting. Refer to http://www.eutelsat.com/satellites/4_5_5.html for more information.

Step 5 Set the **Absolute Position** of the satellite, in degrees. You can enter a value in the range from 0.0 to 75.0 degrees.

Step 6 The Tuner Performance section is the same as the Tuner Performance section in the User Action mode. For more information, see above.

Step 7 Click **Apply**.

Setting up SI Receive Parameters

Proceed as follows to setup the SI Receive parameters:

- Step 1** From the user interface of the D9865, click **Input > Satellite**, expand **Tuning Setup** and then click **SI Receive Setup**. The SI Receive Setup page is displayed.

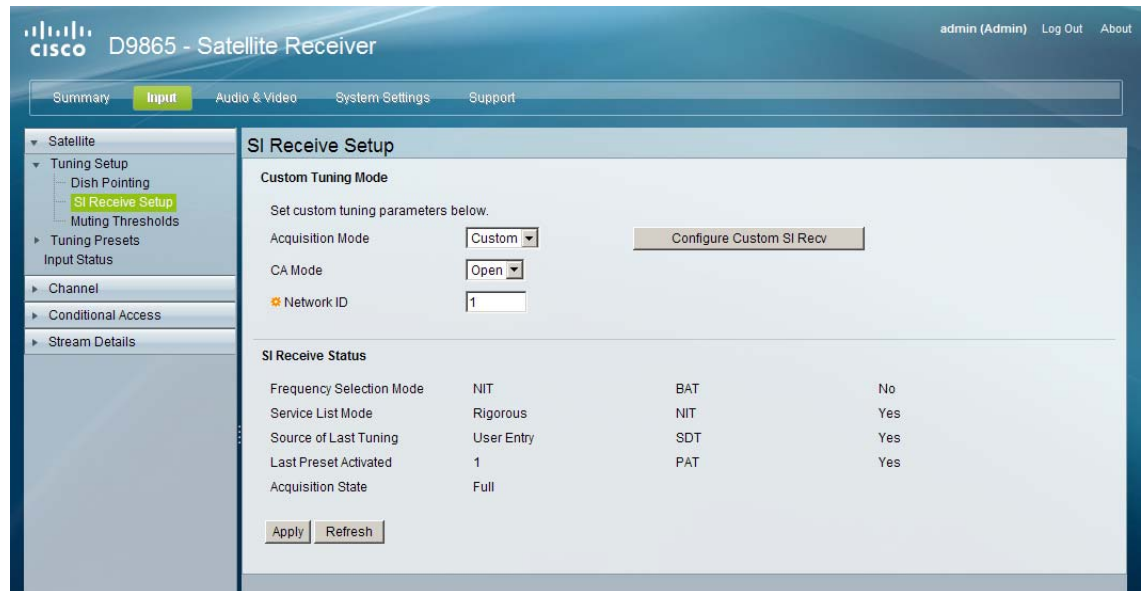

- Step 2** From the **Acquisition Mode** drop-down list, select the mode used to build channel lists from allowed service lists. The selections are Auto, Basic, or Custom. The default is Basic.

If you select Custom, click **Configure Custom SI Recv** and the Configure Custom SI Recv window opens:

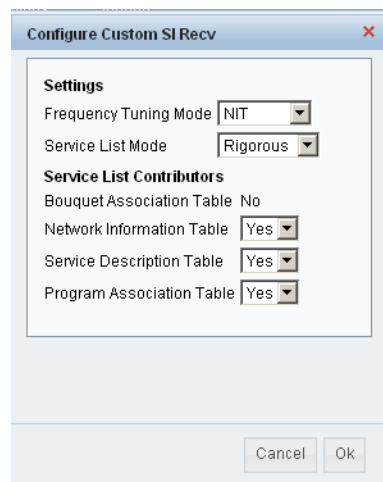

- Step 3** Set the **Frequency Tuning Mode**, which determines whether the receiver is to be tuned to the received signal using the NIT or User Cfg (user configurations).
- Step 4** The **Service List Mode** determines which tables to use to obtain tuning and channel lists.

Select **Rigorous** if all the default settings must be present in the received signal.

Select **Degraded** if only the table parameters present in the received signal will be used to install the receiver. The default is Rigorous.

- Step 5** The Service List Contributors section allows you to set up custom properties. The following table shows some possible configurations for the allowed service lists and the different frequency tuning settings.

Allowed Service Lists	Custom
Bouquet Association Table (BAT) (not supported)	N
Network Information Table (NIT)	N
Service Description Table (SDT)	N
Program Association Table (PAT)	Y
Frequency Tuning mode	User Cfg



Note You cannot change the Bouquet Association Table value. It is not supported in the current release.

- Step 6** Click **OK**.

- Step 7** Select the Conditional Access (**CA**) **Mode** that determines which programs can be viewed via the receiver. You can select Std (preferred) or Open.



Caution In Open mode, the receiver ignores inconsistent scrambling descriptions within the signal. Operating in this mode may cause the decoder not to respond to certain advanced uplink controlled features, such as service replacement.

- Step 8** Enter the **Network ID**, obtained from your service provider.

- Step 9** The **SI Receive Status** section displays all the current SI Receive settings. It also displays the source of last tuning, the last Preset Number activated, and the current settings of the allowed services (BAT, NIT, SDT, PAT).

- Step 10** Click **Apply**.

Setting up Muting Threshold Controls

Proceed as follows to set up the muting threshold controls:

- Step 1** From the user interface of the D9865, click **Input > Satellite**, expand **Tuning Setup** and then click **Muting Thresholds**. The Muting Thresholds page is displayed.

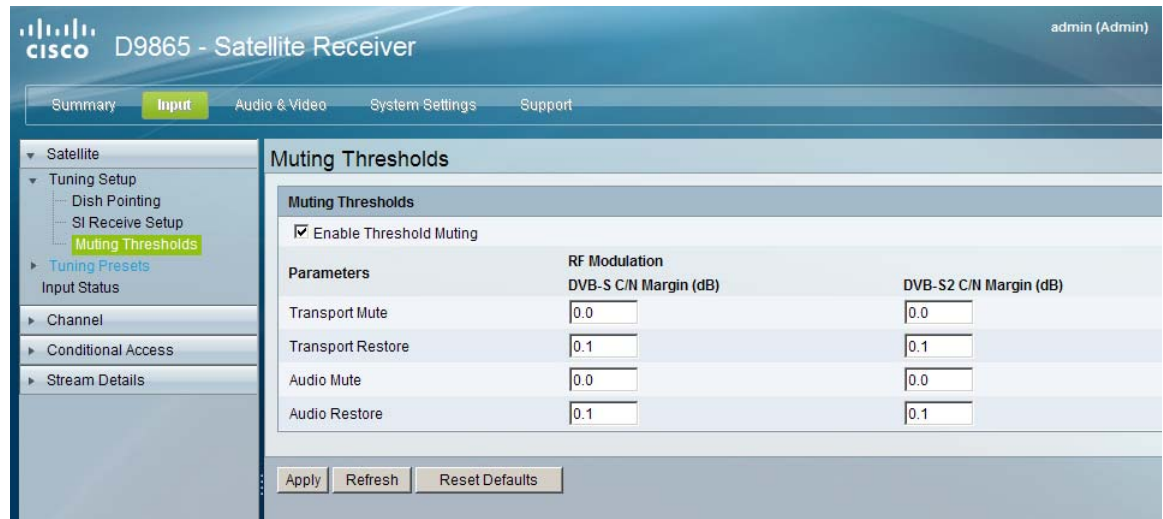

- Step 2** Select **Enable Threshold Muting** to mute the transport stream and audio in the event of an unstable signal, poor signal, or no signal condition. The default is selected.
- Step 3** The **Transport Mute** and **Restore** for both **DVB-S C/N Margin** and **DVB-S2 C/N Margin** sets how the receiver reacts when the signal quality is severely degraded when using DVB-S or DVB-S2 modulation. This allows you to set the transport C/N margin values for the receiver. The receiver uses these noise values/settings as limits during normal operation to determine whether to mute the transport in the event of a noisy signal, poor signal or no signal condition.

The **Transport Mute** is the lower limit for the transport C/N margin setting. The transport will be muted when the C/N margin is below the mute setting for a nominal delay of 1 second. The delay is between the time the condition is first detected and the time the transport is muted. The adjustable operating range is from -5.0 to 20.0 dB. The default setting for Transport Mute is 0.0.

The **Transport Restore** is the upper limit for the transport C/N margin setting. The transport will be un-muted (e.g., restored) when the C/N margin rises above the Transport Restore setting for a nominal delay of 8 seconds. The delay is between the time the condition is first detected and the time the transport is muted. The adjustable operating range is from -5.0 to 20.0 dB. The default setting for Transport Restore is 0.1.

Figure 5-1 Transport Default C/N Margin Relationship

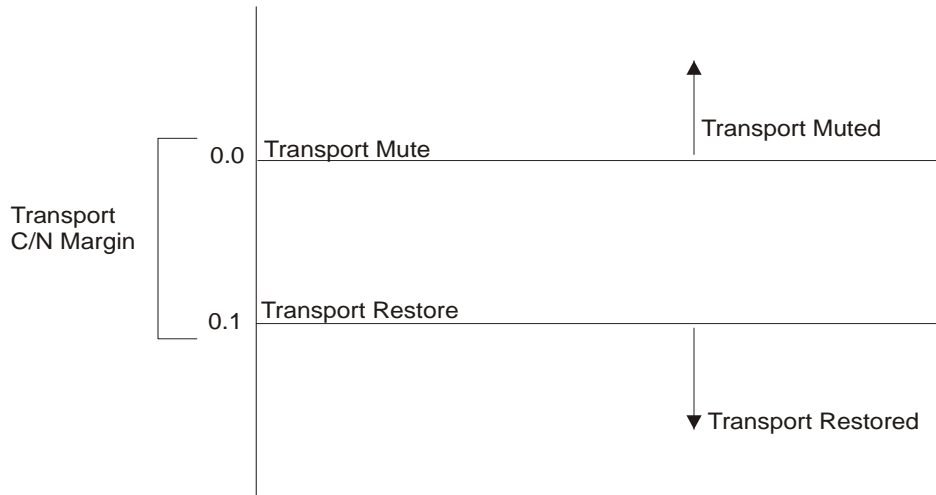

Step 4 The **Audio Mute** and **Restore** for both DVB-S C/N Margin and DVB-S2 C/N Margin sets the Audio channel Mute and Restore C/N margin values (limits) to mute audio when the signal quality is severely degraded when using DVB-S or DVB-S2 modulation.

The **Audio Mute** is the lower limit for the audio C/N margin setting. Audio will be muted when the C/N margin is below the Cutoff setting for a nominal delay of 4 seconds. The delay is between the time the condition is first detected and the time the transport is muted. The adjustable operating range is from -5.0 to 20.0 dB. The default setting for Audio Mute is 0.0.

The **Audio Restore** is the upper limit for the audio C/N margin setting. Audio will be un-muted (e.g., restored) when the C/N margin rises above the Restore setting for a nominal delay of 8 seconds. The delay is between the time the condition is first detected and the time the transport is restored. The adjustable operating range is from -5.0 to 20.0 dB. The default setting for Audio Restore is 0.1.

Figure 5-2 Audio Default C/N Margin Relationship

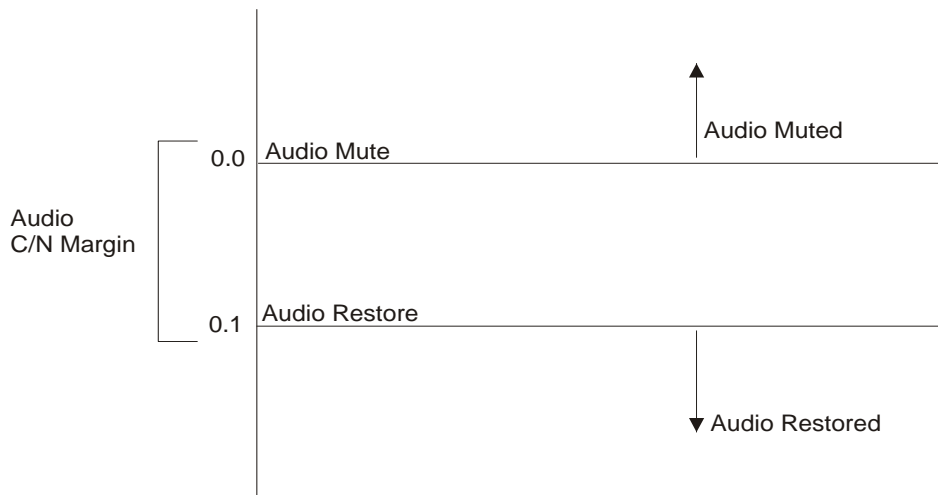

Step 5 Click **Apply**. If you want to restore the transport stream and audio C/N margin options to their factory set (default) values, click **Reset Defaults**.

Setting up the Tuning Presets/LNB

The Tuning Presets page allows you to select or configure up to 64 network presets. Your receiver may be shipped pre-configured with a number of network presets. You can configure the network preset to use one of 10 LNB configurations.

Proceed as follows to set up the Tuning Preset/LNB:

- Step 1** From the user interface of the D9865, click **Input > Satellite > Tuning Presets**. The Tuning Presets page is displayed.

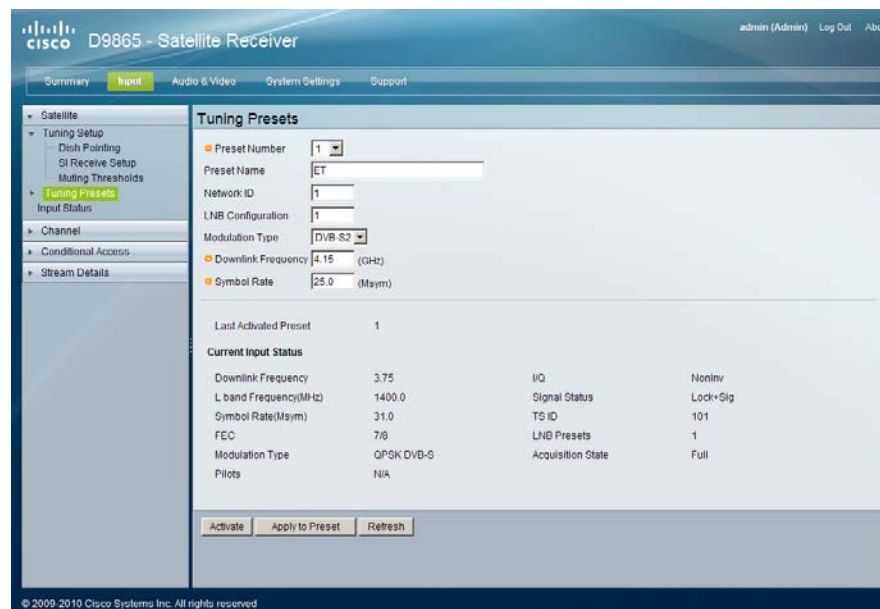

- Step 2** Select the **Preset Number**, a value in the range from 1 to 64.
- Step 3** Enter the **Preset network Name**.
- Step 4** Enter the **Network ID**, obtained from your service provider.
- Step 5** Enter the **LNB Configuration**, a value in the range from 1 to 10.
- Step 6** Select the **Modulation Type** for the received signal (DVB-S or DVB-S2).
- Step 7** Set the **Downlink Frequency** used by the receiver for tuning the received digital signal. You can enter a value in the range from 0.0 to 15.0 GHz. The formula for C-Band is: Downlink Freq = LO Freq - L-Band Freq. The formula for Ku-Band is Downlink Freq = LO Freq + L-Band Freq.
- Step 8** Type the **Symbol Rate**. The symbol rate must match that of transmitted signal. You can enter a value in the range from 1.0 to 45.0 MS/s for DVB-S or 1.0 to 31.0 MS/s for DVB-S2.
- Step 9** The **Last Activated Preset** displays the number of the last activated preset.
- Step 10** The **Current Input Status** section displays the current RF Tuning Status information, including the downlink frequency and signal status.
- Step 11** Click **Apply to Preset** to apply the settings to the receiver.

Click **Activate** to choose the preset. This will activate the currently displayed preset as the active preset. You will be prompted to accept the new preset and warned that service interruption will occur.

Setting up LNB Presets

Proceed as follows to set up the LNB Presets:

- Step 1** From the user interface of the D9865, click **Input > Satellite**, expand **Tuning Presets** and then click **LNB Presets**. The LNB Presets page is displayed.



- Step 2** Select the **LNB Configuration** number, identifying the current present LNB configuration. You can select a number in the range from 1 to 10.
- Step 3** The **LNB Power** setting determines if power is provided via the input to an external LNB connection. You can set the LNB Power to Off, 18-H, 13-V, H-NIT, or V-NIT. The default is 18-H. If LNB Power is set to V-NIT or H-NIT, the signal polarization is automatically read from the NIT. Power will not be applied to the LNB if LNB Power is set to Off.



Note LNB power must be on if DiSEqC is required.

For more information, see [LNB Power Settings, page 4-21](#).

- Step 4** The **LO Select** is only applicable for dual-band LNB applications. It sets whether or not the 22 KHz tone is available. The selections are On, Off, or Auto (if downlink frequency is greater/less than the crossover frequency, the 22 KHz tone is automatically set to on/off). The default is Off.
- Step 5** Set the Local Oscillator Frequency #1 (**LO Freq 1**), which sets the satellite antenna LNB local oscillator #1 frequency. For C-Band application, set to 5.15 GHz. For Ku-band single LNB, enter LO Freq and set LO Freq 2 and Crossover Frequency to 0.0. For Ku-band dual LNB, enter LO Freq 1, LO Freq 2 and Crossover Frequency. The default is 10.75 GHz.
- Step 6** Set the Local Oscillator Frequency #2 (**LO Freq 2**), which sets the satellite antenna LNB local oscillator #2 frequency. This option is only used in dual-band LNB applications. LO Freq 2 must be greater than LO Freq 1. The default is 0.0 GHz.

Step 7 Enter the **Crossover**. This is an internal threshold frequency used for selecting the LO1 or LO2 frequency, depending on the current downlink frequency settings. This option is only used in dual-band LNB applications. The default is 0.0 GHz.

Step 8 Enable or disable the Digital Satellite Equipment Satellite Control (**DiSEqC**).



Note This must be enabled to control the DiSEqC switch. LNB Power must be on to use this setting. Refer to http://www.eutelsat.com/satellites/4_5_5.html for more information.

Step 9 In the **DiSEqC Switch** drop-down list, select a port on the LNB switch, if used (Off, A to P).

Step 10 Click **Apply to Preset**.

Viewing Input Status

Proceed as follows to view the Input Status page:

From the user interface of the D9865, click **Input > Satellite > Input Status**. The Input Status page is displayed.

The screenshot shows the Cisco D9865 - Satellite Receiver web interface. The top navigation bar includes 'Summary', 'Input', 'Audio & Video', 'System Settings', and 'Support'. The left sidebar shows a tree view with 'Satellite' expanded, containing 'Tuning Setup', 'Tuning Presets', and 'Input Status' (highlighted). The main content area is titled 'Input Status' and is divided into two sections: 'Current Input Status' and 'Tuner Performance'.

Current Input Status			
Downlink Frequency	3.75	I/Q	NonInv
L band Frequency(MHz)	1400.0	Signal Status	Lock+Sig
Symbol Rate(Msym)	31.0	TS ID	101
FEC	7/8	LNB Presets	1
Modulation Type	QPSK DVB-S	Acquisition State	Full
Pilots	N/A		

Tuner Performance			
C/N Margin	-2.5	24.6	31.0
Signal Level	-85	-65	-25
RF Lock	Lock	PV BER	0.00e-7
AFC	-0.1	RF(1) Power	H
LDPC ER	N/A	LNB Status	Normal
Packet ER	0.00e-8		

Net ID		Network Name	
Input Rate	0.0	Scrambling Mode	Unk
LNB Power Supply Status (Operational)	Normal		

© 2009-2010 Cisco Systems Inc. All rights reserved

The Input Status page displays the active input port receiving the signal.

The **Current Input Status** section displays current RF Tuning Status information, including the downlink frequency and signal status.

The **Tuner Performance** section displays the satellite dish status, such as the C/N Margin and Signal Level.

Setting the Channel Information

Proceed as follows to select a channel and view the channel information:

- Step 1** From the user interface of the D9865, click **Input > Channel**. The Channel Selection page is displayed.

Type	PID
PMT	5601
PCR	6124
VID	6124
DPI	8007
AUD	6100
AUD	6102

- Step 2** Select the **Channel number** from the list of available channels.



Note

Subscriber uplink services made available to your satellite receiver are associated with virtual channels. These channels can include video, audio, and/or data services. All authorized virtual channel services are provided via PNC system software and broadcast facility equipment, and are decoded by the receiver. You can view available subscriber services for any received virtual received channel on this menu and tune to the selected channel by entering the particular channel number.

- Step 3** Click **Apply**. The channel is selected and the selected channel is displayed on-screen.

- Step 4** The **Channel Status** section displays the following information:

Channel Information	Description
Conditional Access System	Indicates the type of CA used for the received signal.
Authorized	Indicates whether the receiver is authorized to receive the signal.
Scrambled	Indicates whether the received signal is scrambled.
Encrypted	Indicates whether the received signal is encrypted.

Step 5 The **PID Information** section displays the PIDs associated with a selected channel.

Configuring the Common Interface (CI) Information

The Common Interface (CI) slot is located behind the door on the front panel. They allow use of a CAM (Conditional Access Module) Smartcard to decrypt purchased programming.



Note

You must be authorized to view the programming available via the Smart Card from your service provider.

CAMs must be purchased from Cisco. For a list of the supported CAMs, see [Common Interface Modules, page 3-4](#).

Proceed as follows to configure the CI settings:

Step 1 From the user interface of the D9865, click **Input > Conditional Access**. The CI Setup page is displayed.

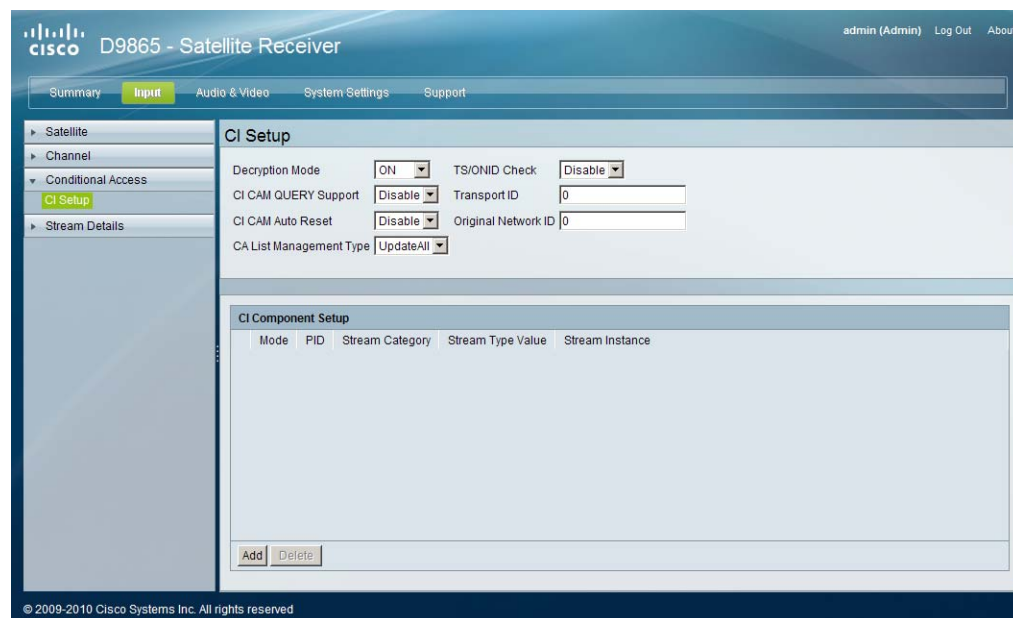

- Step 2** The **Decryption Mode** determines whether to decrypt the program on the selected CAM (Yes, No, Comp). Select Comp to customize the PID or stream type to decrypt.
- Step 3** Select Enable in the **CI CAM QUERY Support** drop-down list to query the CAM prior to decryption to ensure that the card can be decrypted. The default is Disable.
- Step 4** Select Enable in **CI CAM Auto Reset** to automatically reset the card. The default is Disable.
- Step 5** In the **CA List Management Type** drop-down list, select **AddDel** (Default) to add or delete programs individually in the CAM. Set to Update All to automatically update and reset all the programs each time you add or modify the programs available via the CAM.
- Step 6** Select Enable in the **TS/ONID Check** drop-down list if you want to restrict the incoming transport stream to the transport ID and transport original network ID listed below. If the incoming stream does not match the specified transport stream, the CAM will not decrypt. The default is Disable.
- Step 7** Set the **Transport ID** and **Original Network ID** if you had set the TS/ONID Check to Enable. If the incoming stream does not match the specified IDs here, the CAM will not decrypt. You can enter a value in the range from 0 to 65535.
- Step 8** If you selected Comp as the **Decryption Mode**, you can insert and maintain customized records in the **CI Component Setup** section. Each record customizes the PID or stream type to decrypt. The Index number is a read only field that indicates the record number. You can maintain up to 32 records. To insert a new record, click **Add**. A new row appears at the top of the table (see below).

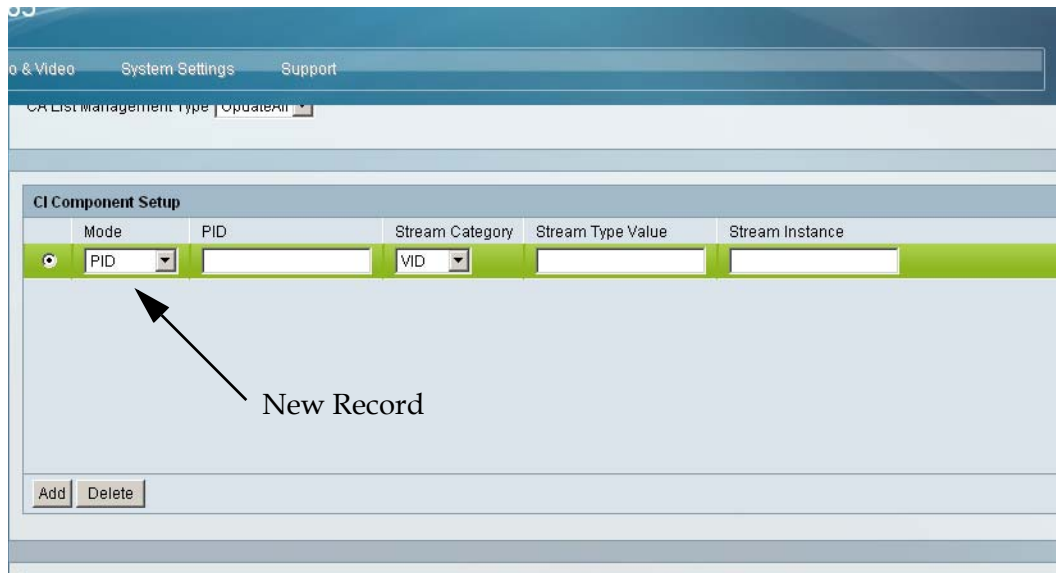

There are various configurations when creating a new record. The following table summarizes the various methods:

If you set by	Parameter Settings
PID	Set Mode to PID and enter PID number.

If you set by	Parameter Settings
Stream Type	Set Mode to Stream, select Stream Category (audio, video, subtitle, ttx, or user) and enter Stream Instance of the stream type. There is an additional configuration if you select user as the Stream Category (see below).
Stream Type: User	Set Mode to Stream, Stream Category to User, manually enter the stream code in Stream Type Value , and then the Stream Instance of the stream type.

- Step 9** If you know the PID number, ensure that PID is selected under **Mode** and enter the appropriate **PID** number. Click **Apply**.
- Step 10** To enter the stream type, select Stream under **Mode**, select the stream type in the **Stream Category** (Vid, Aud, Subt, or TTX) and enter the instance of the stream type in **Stream Instance**. You can enter a range from 1 to 64. Click **Apply**.
- Step 11** If you do not know the stream type, you can specify a specific hex value as the stream type. Select **Stream** under **Mode**, select User under **Stream Category**, enter the hex value of the stream under **Stream Type value (hex)** and the instance of the customized stream type in **Stream Instance**. You can enter a two digit hexadecimal value for the Stream Type and a range from 1 to 64 for the Stream Instance. Click **Apply**.
- Step 12** To delete a record, identify the record you want to remove and click **Delete**.
- Step 13** Scroll down to view the **CI Status** information:

CI Status	
Sys Name	AlphaCrypt
Comp Name	SCM
Manufacture Code	18976
Manufacture ID	18976
Serial Number	Unknown
Hardware Version	Unknown
Application Version	3.12
CAM Status	Ready

The following table describes the CI Status:

CI Status	Description
Sys Name	System name of the CAM.
Comp Name	The company name of the CAM.
Manufacture Code	The manufacturer's code.
Manufacture ID	The factory loaded application number of the CAM.
Serial Number	The unique serial number of the CAM.
Hardware Version	The hardware version number of the CAM.
Application Version	The software version number of the CAM.
CAM Status	Status of the CAM (Ready or Not Ready).

Step 14 Scroll down to view the **System ID** information.

System ID		
Index	Name	ID
1	Irdeto	1542
2	Irdeto	1538
3	Irdeto	1540
4	Irdeto	1544
5	BetaTechnik	5890
6	BetaTechnik	5922
7	BetaTechnik	5986
8	AlphaCrypt	18976
9	France Telecom	1280
10	Norwegian Telekom	2816
11	Kudelski SA	6144
12	Kudelski SA	6145
13	CryptoWorks (Irdeto)	3328
14	CryptoWorks (Irdeto)	3331
15	CryptoWorks (Irdeto)	3333
16	CryptoWorks (Irdeto)	3340
17	CryptoWorks (Irdeto)	3362

The following table describes the System ID information:

System ID	Description
Index	Indicates the customized record number (1 to 64, up to 32 records for each CAM).
Name	System name of the CAM.
ID	Displays the CA system identification ID of the CAM. Some CAMs may support multiple CA system IDs.

Step 15 Click **Apply**.

Viewing the PSI Tables

Proceed as follows to view the PSI tables:

From the user interface of the D9865, click **Input** > **Stream Details** > **PSI Tables**. The PSI Tables page is displayed.

Table Type	Table ID Extension	Status	Version	PID	Number of Sections
PAT	101	Full	4	0	1
CAT	65535	Full	30	1	1
PMT	601	Full	13	5601	1
NIT	1	Full	2	16	1
SDT	101	Full	2	17	1
TDT	0	Full	0	20	1

The PSI Table is read-only. The following is a list of the various columns:

Abbreviation	Description
Table Type	Table Type (i.e., NIT, PMT, etc.)
Table ID Extension	MPEG/DVB Table ID
Status	Reception Status
Version	Table Version number
PID	Program PID number
Number of Sections	PSI tables are received in sections. This indicates the section number received. This information is useful for diagnostics/troubleshooting purposes.

Viewing PSI Frequency Information

Proceed as follows to view the PSI Frequency table:

From the user interface of the D9865, click **Input** > **Stream Details** > **PSI Frequency**. The PSI Frequency page is displayed.

Transport Stream ID	Frequency (GHz)	Symbol Rate (MSym)	Orbital Position	Polarization	Flag	FEC	RF Modulation	Network ID
101	12.25	30.8	126.0	Horiz	East	7/8	QPSK DVB-S	1
201	12.31	30.0	120.0	Horiz	East	3/4	8PSK DVB-S2	1

The PSI Frequency table is read-only. The following is a list of the various columns:

Abbreviation	Description
Transport Stream ID	Transport ID
Frequency (GHz)	Downlink Frequency (GHz)
Symbol Rate (MSym)	Symbol Rate (Msym/s)
Orbital Position	Orbital Position (in degrees)
Polarization	Polarity of the received signal (H,V, or Off)
Flag	Satellite position (in degrees), in combination with the direction (East or West)
FEC	Forward Error Correction inner code rate
RF Modulation	Modulator constellation setting
Network ID	Original Network ID

Viewing the PSI Channels

Proceed as follows to view the PSI Channels table:

From the user interface of the D9865, click **Input > Stream Details > PSI Channel**. The PSI Channel page is displayed.

The screenshot shows the Cisco D9865 - Satellite Receiver web interface. The top navigation bar includes 'Summary', 'Input', 'Audio & Video', 'System Settings', and 'Support'. The left sidebar shows a tree view with 'Satellite' expanded, and 'Stream Details' selected. The main content area displays the 'PSI Channel' table with the following data:

PSI Channel Information					
Service ID	TS ID	Program Name	PMT PID	ECM PID	
1	101	SV_1	5001	---	
2	101	SV_2	5002	---	
3	101	SV_3	5003	---	
4	101	SV_4	5004	---	
5	101	SV_5	5005	---	
6	101	SV_6	5006	---	
7	101	SV_7	5007	---	
501	101	SV_501	5501	---	
502	101	SV_502	5502	---	
601	101	SV_601	5601	---	
602	101	SV_602	5602	---	
603	101	SV_603	5603	---	
604	101	SV_604	5604	---	

The PSI Channel table is read-only. The following is a list of the various columns:

Abbreviation	Description
Service ID	Virtual Channel
TS ID	Transport Stream ID
Program Name	Name of the program
PMT PID	Program Map Table PID
ECM PID	Entitlement Control Message PID

Setting up the Video

Proceed as follows to set up the video information:

- Step 1** From the user interface of the D9865, click **Audio & Video > Video Setup**. The Video Setup page is displayed.

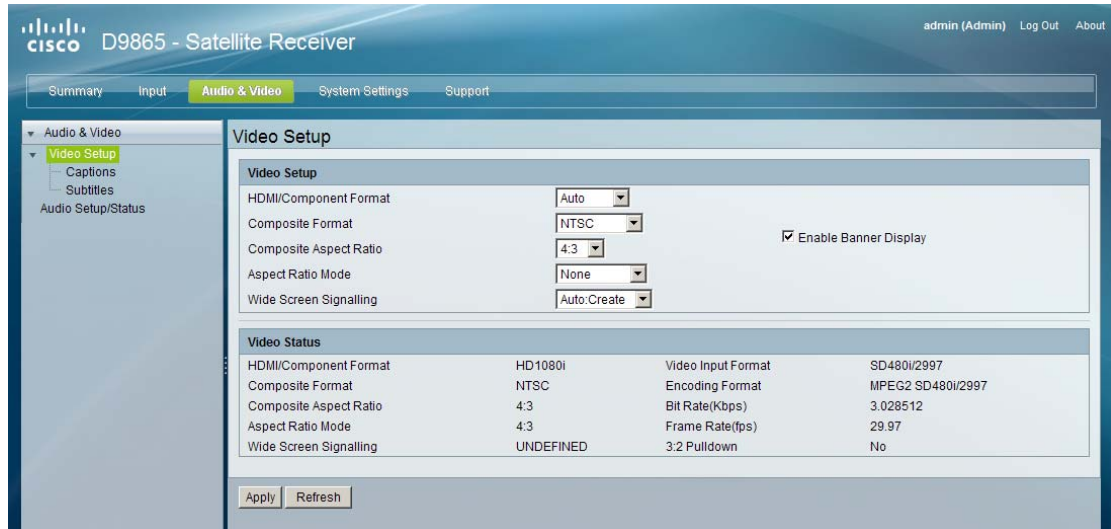

- Step 2** Select HD output video format from the **HDMI/Component Format** drop-down list (**HD 1080i** or **HD720p**). Select Auto for the receiver to automatically detect the correct HD video format.
- Step 3** Set the **Composite Format**. Select PAL-B/G, PAL-D, or PAL-I for 625-line systems. Select PAL-M for 525-line format for Brazil. Select PAL-N (AR) for 625-line format for Argentina. Select NTSC or NTSC-J for 525-line systems. Select Auto for the receiver to automatically detect the correct SD video format.
- Step 4** Select the **Composite Aspect Ratio** of the intended TV system (4:3 or 16:9).
- Step 5** The **Aspect Ratio Mode** is the conversion that the receiver will perform on the incoming signal for the picture to be displayed correctly (i.e., to correspond to the aspect ratio of your TV) on your TV, based on your selection.

The options are None, Auto, Auto AFD, 16:9 L/B, 4:3 P/B, 14:9, 4:3 CCO, and 16:9 SCALE. The default is None.



Note For the actual conversion performed, refer to [Actual Conversion Table, page 4-28](#).

- Step 6** Select the Wide Screen Signalling output mode. It is used to select how the receiver affects PAL WSS when it is present in the VBI. The table below describes each of the options. The default is Auto.

WSS Mode	Description
Passthrough	Passes WSS (unmodified, as received by the D9865 receiver) on VBI Line 23 when present.
Auto:Create	Creates WSS to output the correct aspect ratio, when performing aspect ratio conversion, otherwise it is passed through.

WSS Mode	Description
Auto:Modify	Modifies WSS to output the correct aspect ratio, when performing aspect ratio conversion, otherwise it is passed through.
Suppress	Disables Line 23 VBI processing. WSS is not output on line 23.

- Step 7** Select **Enable Banner Display** to display the signal status and other information at the top of the screen.
- Step 8** The **Video Status** section displays the current video information, such as the aspect ratio mode, encoding format, and bit rate.
- Step 9** Click **Apply**.

Configuring Captions

Proceed as follows to set up the caption parameters:

- Step 1** From the user interface of the D9865, click **Audio & Video**, expand **Video Setup** and then click **Captions**. The Captions page is displayed.

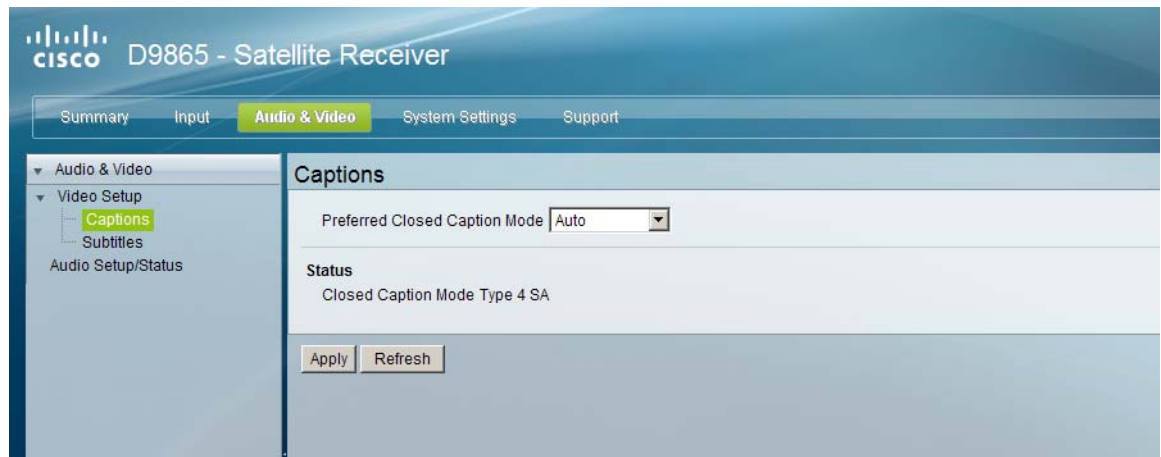

- Step 2** Select the **Preferred Closed Caption Mode**. There are multiple in the stream. The default is Auto.



Note SA Custom is not supported when telecine video coding is enabled.

- Step 3** The **Status** section displays the actual caption mode used. This is read-only.
- Step 4** Click **Apply**.

Setting up Subtitles

Proceed as follows to set up the subtitles:

- Step 1** From the user interface of the D9865, click **Audio & Video**, expand **Video Setup** and then click **Subtitles**. The Subtitles page is displayed.

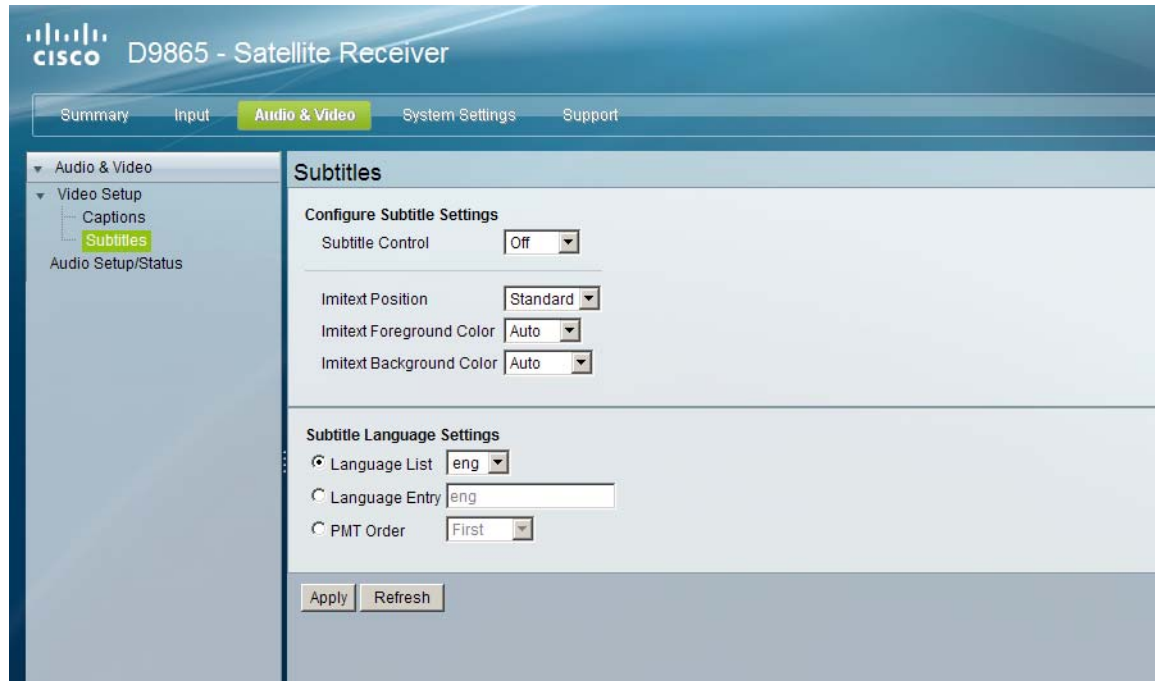

- Step 2** Select the **Subtitle Control** to use to display the program subtitles. The following table describes each of the available options.

Op Mode Selection	Description
Off	No subtitles are displayed.
On	Functions as an “Auto” setting. DVB subtitles are displayed when only DVB subtitles are transmitted on the channel, and likewise, Imitext subtitles are displayed when only Imitext subtitles are transmitted on the channel. When both DVB and Imitext subtitles are available on the same channel, only DVB subtitles will be displayed.
DVB	Displays only DVB subtitles. For example, if DVB is selected, but both DVB and Imitext subtitles are being transmitted on the same channel, only DVB subtitles will be displayed.
Imitext	Displays only Imitext subtitles. For example, if Imitext is selected, but both DVB and Imitext subtitles are being transmitted on the same channel, only Imitext subtitles will be displayed.

- Step 3** Select the **Imitext Position** of the on-screen subtitle text. Select Standard for subtitles to appear on screen in the same position as output from other PowerVu receivers. Select Extended to position subtitles on screen according to the Imitext (extended) specification.
- Step 4** The **Imitext Foreground Color** sets the color of Imitext subtitles only. Auto displays text in the color transmitted by the subtitling equipment. Yellow and White overrides the color set by the uplink and display text in the selected color.
- Step 5** The **Imitext Background Color** sets the background on which Imitext subtitles are displayed. The following table identifies the affect each setting has on the displayed subtitle text:

BackGround Option	Description
Auto	Displays background in same shade transmitted by the subtitling equipment.
Shadow	Applies an outline to the right side of each text character. No background box is applied to subtitles, i.e., text is visible directly on top of video.
Opaque	Applies a black box to each text character.
Semi	Applies a semi-transparent box to subtitle text.
None	No shadow or outline is applied to subtitle text.

- Step 6** In the **Subtitle Language Settings** section, select the language type to display the subtitles. The default is Language List. Language Entry and PMT Order are more applicable for advanced applications. The following table describes each of the available options and how to set them:

Select Language By Option	Description
Language List	Each subtitling PID can contain multiple languages. Use this setting to select the language from the Language List by scrolling through the available selections. If Language List is selected, PMT Order and Entry fields are not used.
Language Entry	Use this setting with Entry to directly enter the language code when the language you want is not in the list. In this case enter the three-character code provided by your uplink service provider (e.g., eng for English).
PMT Order	Use this setting to select one of up to eight languages as assigned in the PMT for the tuned channel on the receiver. Scroll through the PMT Order to select the correct language within the order (i.e., First to Eighth), available from your uplink service provider.

- Step 7** Click **Apply**.

Setting up Audio

Proceed as follows to set up the audio:

- Step 1** From the user interface of the D9865, click **Audio & Video > Audio Setup/Status**. The Audio Setup/Status page is displayed.

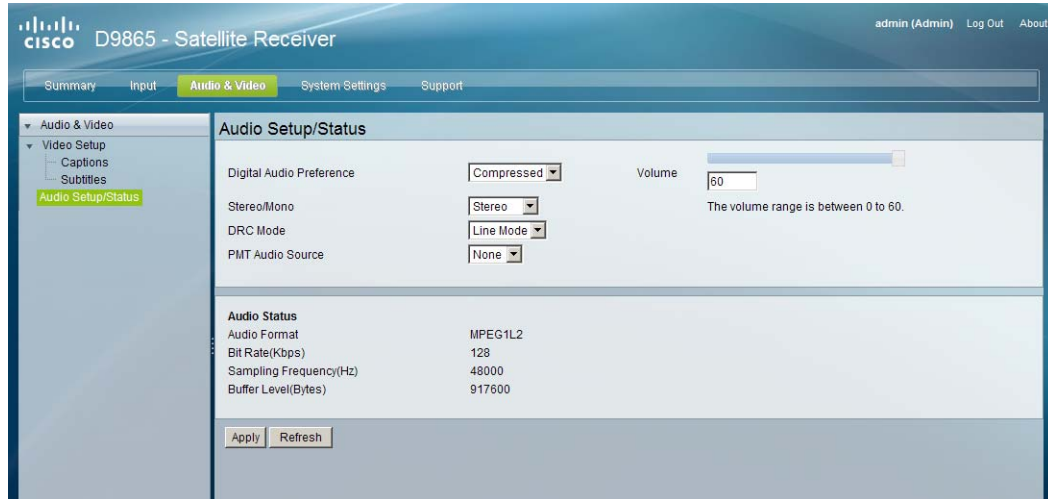

- Step 2** Set the compressed audio type from the **Digital Audio Setting** drop-down list (PCM, Dolby Digital, Compressed). For more information on the effects of Dolby Audio Preference setting on audio outputs, based on the type of audio being decoded, see [Digital Audio Preference Settings, page 4-34](#).
- Step 3** Set the audio mode (Stereo/Mono), which configures how audio received on the audio input is handled. Select Stereo (Left and right channels are output on L and R respectively), Mixed (Left and right channels are combined and output on both L and R), L-Mono (Left channel is output on L and R), or R-Mono (Right channel is output on L and R).
- Step 4** Select the **DRC Mode** (RF Mode or Line Mode). RF Mode is normally used for analog cable modulators, when limited dynamic range is desired. Line Mode is used when full dynamic range is allowed.
- Step 5** Select the **PMT Audio Source** for the audio channel (None or AUD1 to AUD64).
- Step 6** The **Volume** adjustment for the audio channel ranges from 0 to 60. You can enter a value or use the provided slider to adjust the volume.
- Step 7** The **Audio Status** section displays the following information:

Audio Status	Description
Audio Format	The received audio channel format (MPEG, Dolby Digital, AAC, HEAAC or Dolby Digital Plus).
Bit Rate (Mbps)	Audio bit rate of the received audio channel, in Mbps.
Sampling Frequency (Hz)	The audio sampling frequency (32, 44.1, or 48 Hz).
Buffer Level (Bytes)	The audio input buffer level, in bytes.

- Step 8** Click **Apply**.

Viewing System Information

Proceed as follows to view the Identification page:

From the user interface of the D9865, click **System Settings > System > Identification**. The Identification page is displayed.



The Identification page displays the parameters associated with the D9865 system, such as model number, customer code, and user address. The following table displays the system information:

Identity Information	Description
Model Number	Indicates the model number of the receiver.
Model Name	Indicates the model name of the receiver.
Catalogue Number	Indicates the catalogue number of the receiver.
Customer Code	Indicates the unique customer code assigned to an organization by Cisco.
Serial Number	Indicates the unique serial number of the receiver.
Tracking ID	This is the unique Tracking ID number that identifies the product version.
User Address	Indicates the user addresses assigned to the receiver.
Ethernet 1 (Control) MAC Address (D9865D only)	Indicates the MAC addresses assigned to the Ethernet interface at the time of manufacture.

Viewing Features/Licenses

Proceed as follows to view the features or license information:

From the user interface of the D9865, click **System Settings** > **System**, expand **Identification** and then click **Features/Licenses**. The Features/Licenses page is displayed.

Hardware Features	
Feature	Present (Stuffed)
EPG	Yes
Localization Memory	Yes
Ethernet	Yes
Low speed data port	Yes
HDMI	Yes
Component Video	Yes
Digital Audio	Yes

The Hardware Features section displays the hardware options installed in the current D9865 satellite receiver.

Setting Up IP Information

To Configure Management and Data Port Settings

Proceed as follows to configure management and data port settings:

From the user interface of the D9865, click **System Settings > System > IP Settings**. The IP Settings page is displayed.

The screenshot shows the Cisco D9865 - Satellite Receiver web interface. The top navigation bar includes 'Summary', 'Input', 'Audio & Video', 'System Settings' (highlighted), and 'Support'. A left sidebar menu lists 'System', 'Identification', 'Features/Licenses', 'IP Settings' (highlighted), 'Time/Clock', 'Favorites & Reminders', 'Alarms', 'Versions', 'Settings File', and 'Security/Accounts'. The main content area is titled 'IP Settings' and contains two sections: 'Management Port Settings' and 'Data Port Settings'. Each section has a heading, a sub-heading 'Enter the port information below', and three input fields: 'IP Address', 'IP Mask', and 'Gateway Address'. The Management Port Settings fields contain the values 192.131.244.6, 24, and 192.131.244.254. The Data Port Settings fields contain the values 192.131.244.7, 24, and 192.131.244.254. At the bottom of the page, there are 'Apply' and 'Refresh' buttons.

For the Management and Data Port Settings, set the following parameters:

Selection	Description
IP Address	Sets the IP Address for its participation in a Network environment. The IP Address is 12 digits in length (###.###.###.###).
IP Mask	Sets Subnet Mask for its participation in a Network environment. You can enter a value in the range from 8 to 32.
Gateway Address	Sets the Network Gateway Address on the Network, used to expose the receiver to a WAN.

Setting Up IP Routing

Proceed as follows to configure the IP Routing settings:

- Step 1** From the user interface of the D9865, click **System Settings > System**, expand **IP Settings** and then click **IP Routing**. The IP Routing page is displayed.

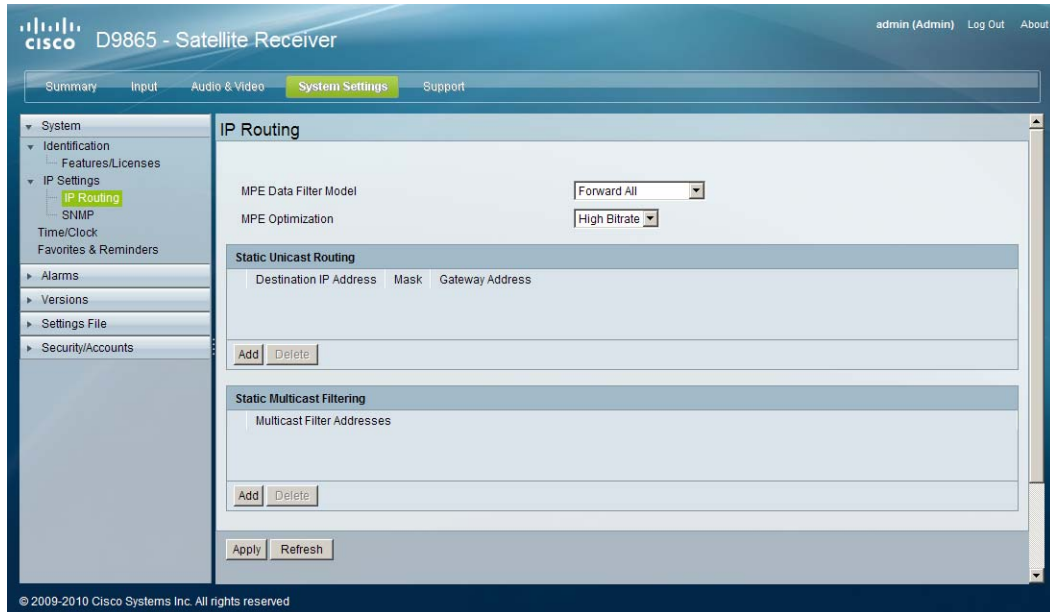

- Step 2** The MPE Data Filter Mode sets whether all the MPE data is forwarded (**Forward All**) via the Gateway. It can forward up to 5 PIDs at the maximum bit rates shown in the following table. Otherwise, select **Forward None**.

MPE Bit Rate	No Decoding	5 Mbps SD Video Decoded	20 Mbps HD Video Decoded
Multicast	30 Mbps	20 Mbps	15 Mbps
Unicast	20 Mbps	15 Mbps	10 Mbps

- Step 3** Set the **MPE Optimization** setting. Select **High Bitrate** (default) to accumulate the IP packets before they are processed in short bursts, increasing the allowable bit rate of MPE data. Select **Low Jitter** to emit the IP packets in a constant stream, resulting in low latency.
- Step 4** The **Static Unicast Routing** displays the static unicast routing addresses for the MPE data. To add a new address, click **Add**. The following is displayed:

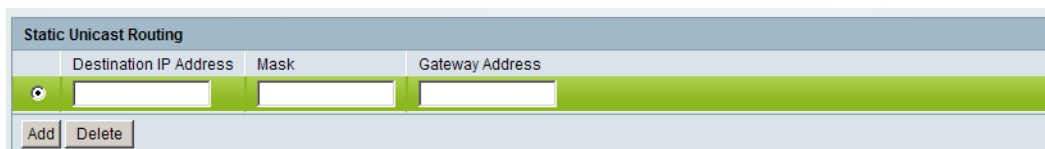

- a. Set the **Destination IP Address** for its participation in a Network environment. The address must be 12 digits in length, in the following format: **###.###.###.###**.

- b. Set the subnet **Mask** for its participation in a Network environment, from 8 to 32.
 - c. Set the network **Gateway Address** used to expose the receiver to a WAN. The address must be 12 digits in length, in the following format: ###.###.###.###.
 - d. Click **Add**.
 - e. To remove an address entry, select the entry and click **Delete**.
- Step 5** The **Multicast Filtering Addresses** section lists the multicast destination IP addresses. To add a new address, click **Add**. The following is displayed:

- a. Enter a **Multicast Filter Address** and click **Add**.
 - b. To remove an address entry, select the entry and click **Delete**.
- Step 6** Click **Apply**.

Setting Up SNMP and Trap Destinations

Proceed as follows to configure the SNMP settings:

- Step 1** From the user interface of the D9865, click **System Settings > System**, expand **IP Settings** and then click **SNMP**. The SNMP page is displayed.

- Step 2** Set the **Read Community String** and the **Write Community String** to public or a custom string. The SNMP Community Read/Write is used when communicating with a device within an SNMP environment. These commands allow you to set the password to read and write data to a device to display

diagnostics traps/alarms. The default community string is public. To set a custom community string, enter an alphanumeric character string up to 31-characters in length identifying the password for the device.



Note The community string is case-sensitive.

Step 3 Enter the **System Name**, **System Location**, and **System Contact** information of the D9865. The system information is sent to the MIB browser, if applicable. The MIB Browser is a third party software used to manage SNMP requests. For more information, contact Cisco customer support.

Step 4 The **Trap Destination Configuration** section displays a list of trap destination address and the associated community string.

To Add a Trap Destination:

1. Click **Add** in the Trap Destination Configuration section.
2. In the **Trap Destination IP Address** field, enter the destination for SNMP trap messages for events (i.e., fault messages). The IP address is up to 12 digits in length (e.g., 155.128.100.200).
3. In the **Community String** field, set the community string for the associated trap IP address. You can enter public or a custom string, up to 31 characters. The default is public.
4. To edit/delete an existing trap destination, select the trap destination entry by clicking on the radio button. Make the necessary changes, or click **Delete** to remove the address from the Trap Destination Configuration list.

Step 5 Click **Apply**.

Configuring Time/Clock Information

Proceed as follows to configure the time/clock settings of the D9865 satellite receiver:

Step 1 From the user interface of the D9865, click **System Settings > System > Time/Clock**. The Time/Clock page is displayed.



- Step 2** Set the **Date Format** of the receiver. The following formats are supported: YYYY/MM/DD, DD/MM/YYYY, MM/DD/YYYY.
- Step 3** Set the **Time Format** of the receiver. Time information is normally broadcast as part of the transmitted digital signal. It is usually the broadcaster local time relative to Greenwich Mean Time (GMT). The following formats are supported: 24 Hr, 24 Hr SuspendZero, 12 Hr, 12 Hr SuspendZero.
- Step 4** Set the **GMT Time Offset**. The time is displayed using a time zone instead of the true local time. If the current broadcast time is not your local time, you must change this time setting in the range from -12:00 to +13.00 in one hour increments.
- Step 5** The **Current Time** displays the current date and time, according to the date and time formats set.
- Step 6** Click **Apply**.

Configuring Favorites and Reminders

Proceed as follows to configure the favorites and reminder settings of the D9865 receiver:

- Step 1** From the user interface of the D9865, click **System Settings > System > Favorites & Reminders**. The Favorites & Reminders page is displayed.

The screenshot shows the Cisco D9865 Satellite Receiver web interface. The top navigation bar includes 'Summary', 'Input', 'Audio & Video', 'System Settings', and 'Support'. The 'System Settings' section is expanded, showing 'Identification', 'Features/Licenses', 'IP Settings', 'IP Routing', 'SNMP', 'Time/Clock', 'Favorites & Reminders', 'Alarms', 'Versions', 'Settings File', and 'Security/Accounts'. The 'Favorites & Reminders' page is displayed, featuring a 'Favorites' section with radio buttons for 'All Channels', 'Authorized Channels Only', 'Sports', 'Favorite4 Name', 'Favorite5 Name', and 'Favorite6 Name'. Below this is a 'One Button Channel Change' section with four colored buttons (Red, Green, Yellow, Blue) and dropdown menus. A 'Reminders' section contains a 'Reminder List' table with columns for Channel Name, Date, Start Time, Reminder Frequency, and Reminder Method. The table lists two reminders: 'ENC1P1 Basic' (2010/05/05, 21:30:00, Once, Reminder Only) and 'ENC1P1 Basic 4' (2010/05/05, 22:00:00, Daily, Reminder Only). An 'Apply' button is located at the bottom of the page.

- Step 2** The **Favorites** section lists all the favorite profiles configured in the D9865. Favorites allow you to surf through the channels you have set up as your favorite channels, skipping over other channels. By default, **All Channels** (authorized or unauthorized channels) are displayed. Select **Authorized Channels Only** to browse channels that are authorized by your uplink provider only.
- Step 3** The **One Button Channel Change** allows you to assign a channel to each of the colored buttons at the bottom of the remote control (see below).



Select a channel to each color as a shortcut for a quick channel change. For example, if you assign the red button to channel 1, pressing the red button while watching a different channel at anytime will automatically tune the TV channel to 1.



Note You can only use the one button channel change if the screen is displaying video only. The one button channel change does not work if EPG, Channel Banner, or on-screen menus are displayed.

Step 4 The **Reminders List** displays a list of reminders set using the on-screen display.

Step 5 Click **Apply**.

To Edit a Favorites Profile

Step 1 Select a favorite profile and click **Edit**. The Edit Favorite screen is displayed. The following is an example:

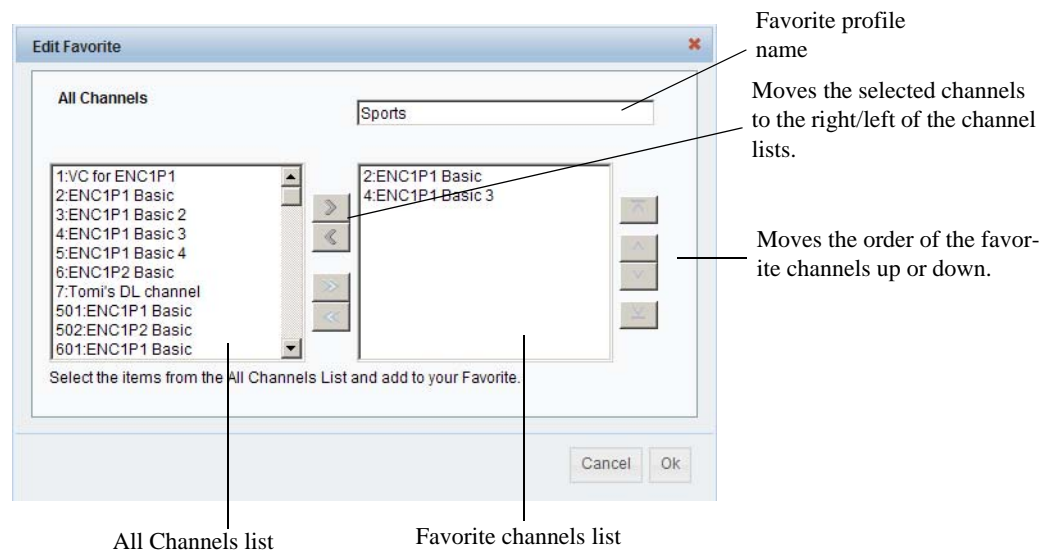

Step 2 Edit the channel profile name, if required.

Step 3 Select the channels from the All Channels list and click right to include the channels in the Favorite profile.

Step 4 Click **OK**.



Note To set a favorite profile as an active profile, select the favorite profile and click **Apply**.

Viewing the Alarm/Warning Status

Proceed as follows to view the active alarm and warning messages:

From the user interface of the D9865, click **System Settings > Alarms > Status**. The Status page is displayed.

The screenshot shows the Cisco D9865 - Satellite Receiver web interface. The navigation menu includes Summary, Input, Audio & Video, System Settings (highlighted), and Support. The left sidebar shows a tree view with System, Alarms (expanded), Status (highlighted), Setup, History, Versions, Settings File, and Security/Accounts. The main content area is titled 'Status' and contains the following sections:

Fault Summary

Type	Number Active
Alarms	0
Warnings	2

Alarm / Warning Status

Type	Name	Text	Set Since
Warning	Ethernet Port 2	ETH Port 2 Link Down	2010/05/03 10:00:05
Warning	TV-Out Settings Problem	Video type not supported	2010/05/03 10:00:05

Refresh Clear

The **Fault Summary** section displays the number of currently active Alarms and Warnings.

The **Alarm/Warning Status** section displays the name of the active alarm/warning, the alarm/warning message, and the date and time of the alarm. For more information on alarm messages, refer to [Alarm Messages, page 6-1](#). For more information on warning messages, refer to [Warning Messages, page 6-10](#).

Setting Up Alarms and Warnings

To Set Up Alarms

Proceed as follows to set up the alarms:

- Step 1** From the user interface of the D9865, click **System Settings > Alarms > Setup**. The Setup - Alarm Setup page is displayed.



- Step 2** The Alarm Setup section displays a list of alarm/fault messages. For more information on alarm messages, refer to [Alarm Messages, page 6-1](#).
- Step 3** Set **Enable/Disable** to **Yes** and the alarm message will be reported. Set to **No** and the fault won't be reported.
- Step 4** Set **Trap** to **Yes** and the SNMP trap message will be sent to the trap destination; otherwise the fault message will be ignored.



Note This is for D9865D only.

- Step 5** Click on the Trap Configuration link to view and/or modify trap destinations. The link will open the SNMP page. For more information, refer to [Setting Up SNMP and Trap Destinations, page 5-37](#).
- Step 6** Click **Apply**.

To Set up Warnings

Proceed as follows to set up the warnings:

From the Setup - Alarm Setup page, click on the **Warning Setup** link at the bottom left hand corner of the page. The Setup - Warning Setup page is displayed.

The screenshot shows the Cisco D9865 - Satellite Receiver web GUI. The main content area is titled "Setup - Warning Setup" and contains a table with the following data:

Warning Name	Enable/Disable	Trap
BackupFail	Yes	Yes
BackupState	Yes	Yes
CAT timeout 0	Yes	Yes
CI Status	Yes	Yes
ECT timeout 0	Yes	Yes
ETH Port 1 Link Down	Yes	Yes
ETH Port 2 Link Down	Yes	Yes
Ethernet MAC	Yes	Yes
Ethernet PHY	Yes	Yes
FW: Resource Use PRI	Yes	Yes
HDCPAuthErr	Yes	Yes
MOD Config	Yes	Yes
MPE near capacity	Yes	Yes
Memory Usage PRI	Yes	Yes
NIT timeout 0	Yes	Yes
PAT timeout 1	Yes	Yes

On the right side of the page, there is a link labeled "Trap Configuration" with the text "Click to view Trap Configuration Page".

- Step 7** The Warning Setup section displays a list of alarm/fault messages. For more information on warning messages, refer to [Warning Messages, page 6-10](#).
- Step 8** Set **Enable/Disable** to Yes and the warning message will be reported. Set to No and the fault won't be reported.
- Step 9** Set **Trap** to Yes and the SNMP trap message will be sent to the trap destination; otherwise the fault message will be ignored.



Note This is for D9865D only.

- Step 10** Click on the Trap Configuration link to view and/or modify trap destinations. The link will open the SNMP page. For more information, refer to [Setting Up SNMP and Trap Destinations, page 5-37](#).
- Step 11** Click **Apply**.

Viewing the Alarm/Warning History

Proceed as follows to view the Alarm/Warning History information:

From the user interface of the D9865, click **System Settings > Alarms > History**. The History page is displayed.

The screenshot shows the Cisco D9865 - Satellite Receiver web interface. The top navigation bar includes 'Summary', 'Input', 'Audio & Video', 'System Settings' (highlighted), and 'Support'. The left sidebar shows a tree view with 'Alarms' expanded to 'History'. The main content area is titled 'History' and contains a table of fault history.

Type	Name	Text	Set Date & Time	Cleared Date & Time
Warning	Transport Error	Continuity Count Error Cleared	2000/01/14 01:35:52	2000/01/14 01:35:52
Warning	Transport Error	Continuity Count Error Cleared	2000/01/14 01:36:22	2000/01/14 01:36:22
Warning	Transport Error	Continuity Count Error Cleared	2000/01/14 01:36:22	2000/01/14 01:36:23
Warning	Transport Error	Continuity Count Error Cleared	2000/01/14 01:36:53	2000/01/14 01:36:53
Warning	Transport Error	Continuity Count Error Cleared	2000/01/14 01:36:53	2000/01/14 01:36:53
Warning	Transport Error	Continuity Count Error Cleared	2000/01/14 01:37:23	2000/01/14 01:37:23
Warning	Transport Error	Continuity Count Error Cleared	2000/01/14 01:37:23	2000/01/14 01:37:24
Warning	Transport Error	Continuity Count Error Cleared	2000/01/14 01:37:53	2000/01/14 01:37:54
Warning	Transport Error	Continuity Count Error Cleared	2000/01/14 01:37:54	2000/01/14 01:37:54
Warning	Transport Error	Continuity Count Error Cleared	2000/01/14 01:38:24	2000/01/14 01:38:24
Warning	Transport Error	Continuity Count Error Cleared	2000/01/14 01:38:24	2000/01/14 01:38:25
Warning	Transport Error	Continuity Count Error Cleared	2000/01/14 01:38:54	2000/01/14 01:38:55
Warning	Transport Error	Continuity Count Error Cleared	2000/01/14 01:38:55	2000/01/14 01:38:55
Warning	Transport Error	Continuity Count Error Cleared	2000/01/14 01:39:25	2000/01/14 01:39:25
Warning	Transport Error	Continuity Count Error Cleared	2000/01/14 01:39:25	2000/01/14 01:39:25
Warning	Transport Error	Continuity Count Error Cleared	2000/01/14 01:39:55	2000/01/14 01:39:56
Warning	Transport Error	Continuity Count Error Cleared	2000/01/14 01:39:56	2000/01/14 01:39:56

© 2009-2010 Cisco Systems Inc. All rights reserved

The alarm and warning History page displays all the past system event messages and their set and cleared dates and times. For more information on the alarm messages, refer to [Alarm Messages, page 6-1](#).

Viewing Version Information

Proceed as follows to view the Version information:

From the user interface of the D9865, click **System Settings > Versions**. The Versions page is displayed.

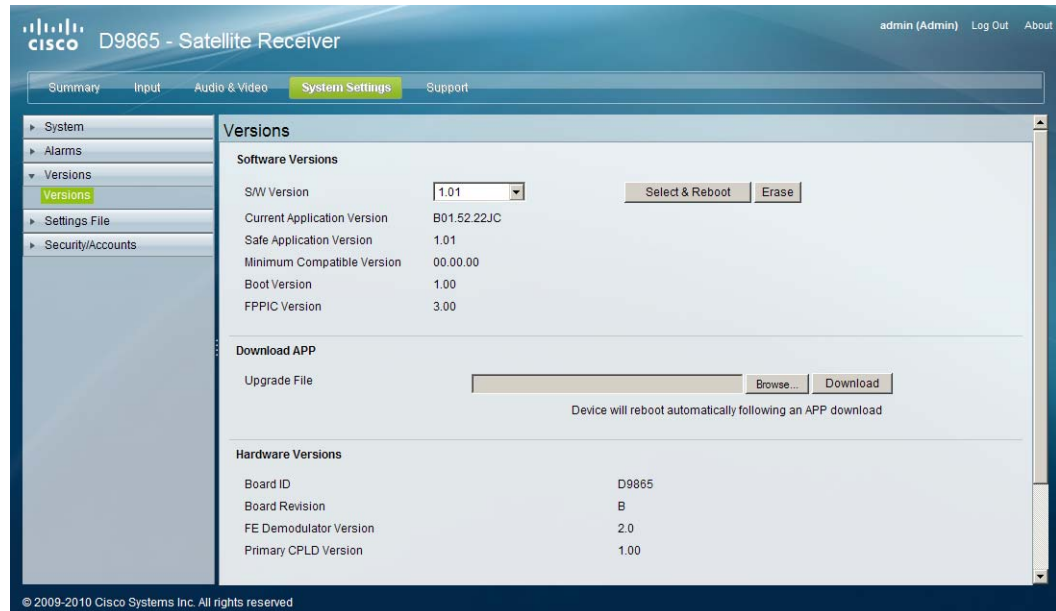

The Versions page displays the following information:

Version Information	Description
Current Application Version	Indicates the currently running loaded application version number.
Safe Application Version	Indicates the factory loaded application version number.
Minimum Compatible Version	Indicates the minimum application version you can download.
Boot Version	Indicates the receiver Boot application version number.
FPPIC Version	Indicates the Programmable Interrupt Controller (PIC) version number.

The **S/W Version** drop-down list allows you to select a different application version application to load to your receiver. Click **Select and Reboot** to reboot the receiver and load the selected application version.

Click **Erase** to remove the selected application version. You will be prompted to continue or not. Press **OK** to continue the deletion.

To Change the Download Application

In the **Download APP** section, click **Browse** to select the new version of the D9865 Satellite Receiver's software application. The Choose File dialog opens. Select the upgrade file and click **Open**. Click **Download** to download the selected upgrade file.

Viewing Hardware Information

The **Hardware Versions** section displays the hardware information of the D9865 Satellite Receiver.

Setting Up Import/Export Information

Proceed as follows to configure the import/export information:

- Step 1** From the user interface of the D9865, click **System Settings > Settings File > Import/Export**. The Import/Export page is displayed.

In the **Device Settings File Transfer** section, you can export and/or import device settings and transport network information.

- Step 2** Select **Export Device Settings & Transport Network Information** and click **Export** to download device settings and transport network information as a file to the designated file folder.
- Step 3** Select **Export User Device Settings** only and click **Export** to download user settings as a file to the designated file folder.
- Step 4** In the **Settings File**, click **Browse**. The Choose File dialog opens.
- Step 5** Navigate to the appropriate folder and select the file with a .bkp file extension and click **Open**.
The Configure Offline FTP Settings File Transfer section has backup and restore controls.
- Step 6** Type the **Settings Filename** of the backup/restore file. You can enter up to 31 characters.
- Step 7** Set the **FTP Server IP Address** of the FTP server used to restore the backup/restore file. The address is up to 12 characters in length (e.g. 171.300.100.200) and in the range from 0 to 255.
- Step 8** Set the **FTP User Name** and **FTP Password** to access the FTP server.



Note The FTP Password is not retained in the receiver. You must re-enter the password before initiating the backup or restore operation.

- Step 9** Set the **FTP Port Number** of the FTP server used to store the backup/restore file. You can enter a port number in the range from 1 to 65535.
- Step 10** Select **Export Device Settings & Transport Network Information** or **Export User Device Settings Only**.
- Step 11** Click **Export** to save the settings to a backup file. Click **Import** to retrieve the last backed up file.

Viewing the Backup/Restore History

Proceed as follows to view the backup and restore Status page:

From the user interface of the D9865, click **System Settings > Settings File > Status**. The Status page is displayed.



The following table shows the Backup History, Restore History, and Operation History table information:

Status	Description
Last Backup File Name	Name of the file that was successfully exported.
Backup Timestamp	Date and time of the last successful backup file saved.
Last Restored File Name	Name of the last file that was successfully restored.
Restore Time Stamp	Date and time of the last successful restore.
Operation Status	Status of the current backup operation (InProgress, Pass, or Fail).
Detailed Operation Status	Detailed processing step for tracking backup progress.
Percentage Completed	Percentage of backup function completed.

Managing D9865 Web GUI Accounts

You can define up to 10 usernames/passwords for login use via Web GUI session on the D9865 Satellite Receiver.

When a user tries to login, the user is required to provide a username and a password. The user is granted access only if this username/password pair exists in the authentication table.

The default user is the “Admin User” and is granted special privileges. The Admin user is allowed to add new users, delete users, change usernames and modify its own password. All other users are only allowed to modify their own passwords.

To Configure the User Login Passwords

Proceed as follows to change the login password:

- Step 1** From the user interface of the D9865, click **System Settings > Security/Accounts > Account Management**. The Account Management page is displayed.

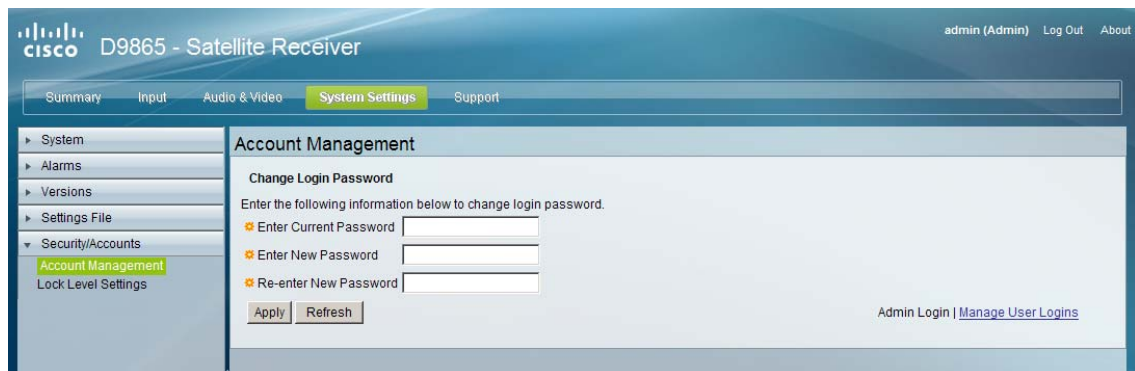

- Step 2** In the **Enter Current Password**, type the current login password.
- Step 3** In the **Enter New Password**, type the new login password.
- Step 4** In the **Re-enter New Password**, type the new login password again to confirm.



Note The **Enter New Password** and **Re-enter New Password** should be identical. Each user, including the admin user, can modify only his own password.

- Step 5** Click **Apply**.

To Add a User Account

This feature is available to a user with Admin privileges only.

Proceed as follows to manage user accounts:

- Step 1** From the user interface of the D9865, click **System Settings > Security/Accounts > Account Management**. The Account Management page is displayed.
- Step 2** Click **Manage User Logins**. The Login Accounts page is displayed.



- Step 3** Click **Add** to create a new login account.



Note You can create a maximum of 10 user accounts.

The Add Login Account window is displayed.

- Step 4** In the **Username** field, enter a user ID. The new username should not match any of the usernames already defined in the Logins Accounts table.
- Step 5** In the **New Password** field, enter a password to assign the user ID. The following are rules for creating a new password:
- It cannot contain any of the Username.
 - It cannot contain any of the following strings: Cisco, sciatl, ocsic, italics, or any string achieved by full or partial capitalization of letters.
 - No letter is repeated more than three times in a row.
 - Must contain a minimum of four characters.
- Step 6** Enter the new password again to confirm in the Confirm New Password field.



Note The **New Password** and **Confirm New Password** should be identical.

- Step 7** In the **Administrator Password** field, enter your Administrator password used to log on to the D9865 web GUI.
- Step 8** In the **Account Type** drop-down list, select User, Admin, or Guest. The following table illustrates the different login types:

Account Type	Access
Guest	View settings only.
User	View and edit settings.
Admin	View, edit settings, and add/delete user accounts.

- Step 9** Click **OK**.

To delete a user account



Note This feature is available to a user with Admin privileges only.

- Step 1** In the Account Management table, select the user you want to remove.
- Step 2** Click **Delete**. The Delete Login Account window is displayed.

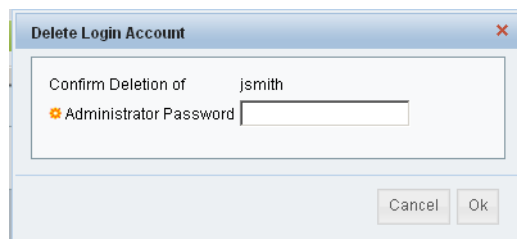

- Step 3** Enter your **Administrator Password** to confirm the deletion.
- Step 4** Click **OK**. The selected user account is deleted.

Configuring Lock Level Settings

Proceed as follows to configure the lock level settings:

- Step 1** From the user interface of the D9865, click **System Settings > Security/Accounts > Lock Level Settings**. The Lock Level Settings page is displayed.

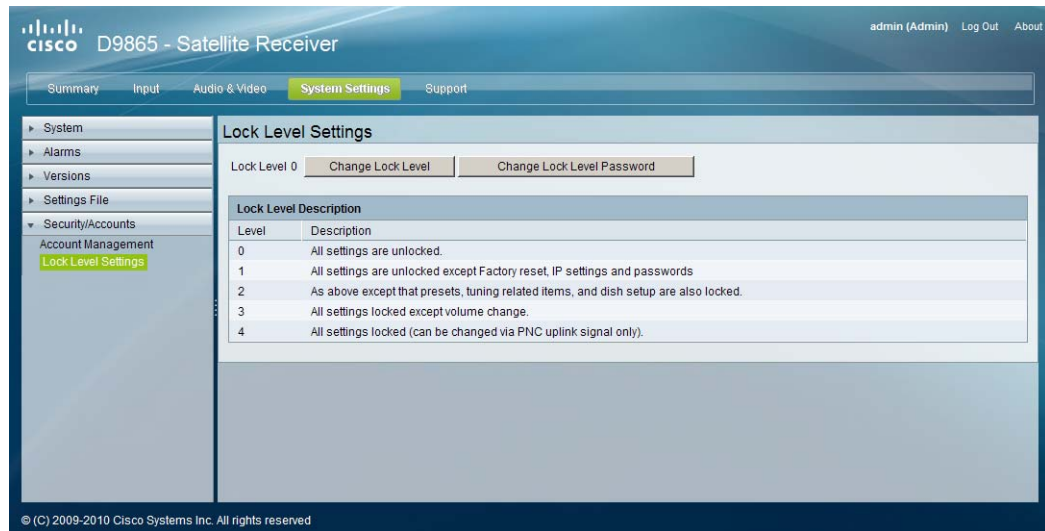

- Step 2** Click **Change Lock Level** and the Change Lock Level window is displayed.

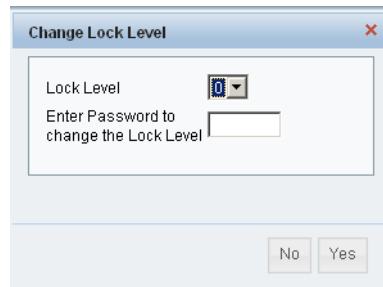

- Step 3** Select the Lock Level which restricts access and prevents unauthorized changes to the receiver settings (0, 1, 2, or 3). The default setting is 0.



Note For details on the four lock levels, see [D9865 Satellite Receiver Lock Levels, page C-1](#).

- Step 4** Enter the Password to change the lock level. The default password is 1234.

- Step 5** Click **Yes**.

If the incorrect lock level or password is entered, an error message appears at the top of the page.

Changing the Lock Level Password

A unique lock level password (4-digit password) protects the current receiver settings against unauthorized changes. When changing the password, record and keep this number in a secure location. The default password is 1234.



Caution

Proceed with caution when changing the password as this operation cannot be undone. If the password is lost or is unavailable, contact Cisco customer support.

To change the lock level password:

- Step 1** In the Lock Level Settings page, click **Change Lock Level Password**. The Change Lock Level Password window is displayed.

- Step 2** Enter the **Current** lock level **Password**.
- Step 3** In the **Enter New Password** field, enter the new password, any number from 0 to 9.
- Step 4** Re-enter the **New Password** and click **Yes**. A message appears informing you that the password was changed successfully.



Note

If the password is lost or is unavailable, contact Cisco customer support.

Viewing Contact Information

Proceed as follows to view contact information:

From the user interface of the D9865, click **Support > Contact**. The Contact Information page is displayed.



The Contact Information page displays all the Cisco customer support information.

Viewing Diagnostic Logs

Proceed as follows to view the Diagnostic Log messages page:

From the user interface of the D9865, click **Support > Logs > Diagnostic Logs**. The Diagnostic Logs page is displayed.

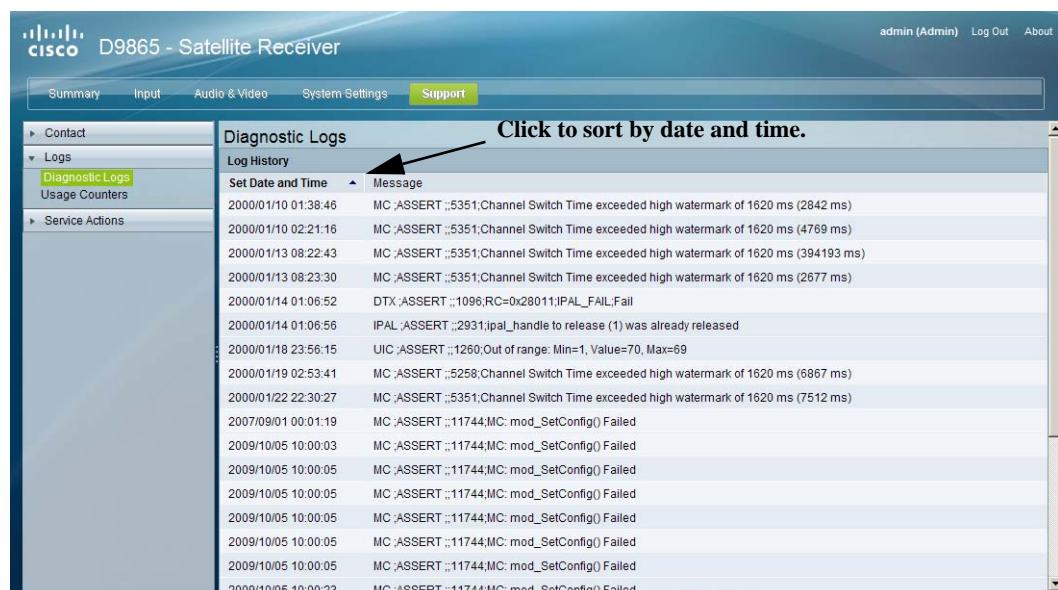

The Diagnostic Logs page displays all the system log messages with their dates and times. Click on the arrow next to **Set Date and Time** column to sort by date and time.

Viewing the Usage Counters

Proceed as follows to view the usage counters:

From the user interface of the D9865, click **Support > Logs > Usage Counters**. The Usage Counters page is displayed.

The screenshot shows the Cisco D9865 - Satellite Receiver web interface. The 'Support' tab is selected in the top navigation bar. On the left sidebar, 'Usage Counters' is highlighted under the 'Logs' section. The main content area displays 'Usage Counter Information' with the following data:

Usage Counter Information	
Production Date and Time	2009/11/16 16:47:39
Last Power On Date and Time	2010/05/05 21:31:45
Lifetime Hours Powered	252
Lifetime Reset Counter	22
Clearable Reset Counter	16
Hours Since Last Power-On/Reset	1
Last Reset Reason	Power up (Power cycle, Manual reset, ...)

Below the table is a 'Clear Reset Counter' button.

The following table describes the Usage Counter Information:

Device Status Information	Description
Production Date & Time	Displays the date and time when the receiver was manufactured.
Last Power On Date and Time	Displays the date and time when the receiver was powered up.
Lifetime Hours Powered	Displays the number of hours since the last power-on.
Lifetime Reset Counter	Displays the total number of times the receiver has been restarted.
Clearable Reset Counter	Displays the number of restarts since the last time the restart counter was cleared. To clear or reset the Clearable Reset Count, click Clear .
Hours Since Last Powered-On/Reset	Displays the total number of hours that the receiver has been operating since the last power-on or restart.
Last Reset Reason	Displays the reason for the last restart, i.e., power cycle or manual reset.

Click **Clear Reset Counter** to clear the **Clearable Reset Counter** field and it resets the counter back to 0.

Performing Service Actions

To Load a Software Version

Proceed as follows to load a software version:

- Step 1** From the user interface of the D9865, click **Support > Service Actions**. The Service Actions page is displayed.

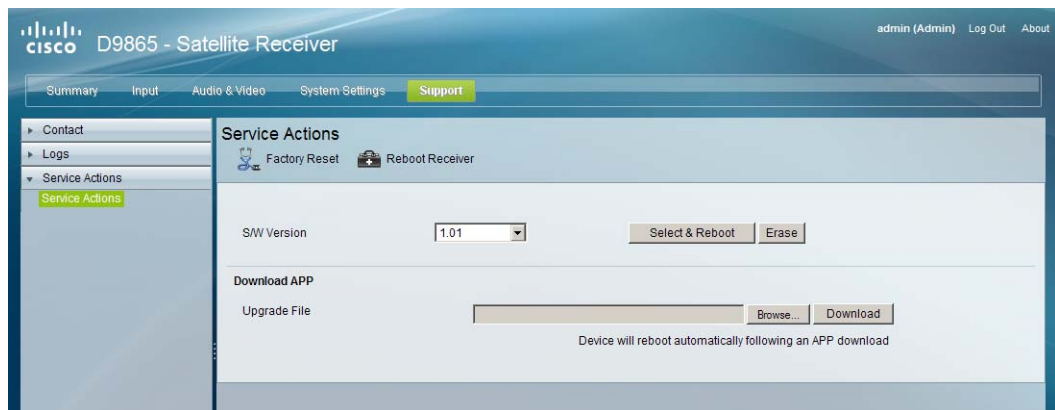

- Step 2** The **S/W Version** drop-down list allows you to select a different application version application to load to your receiver. Click **Select and Reboot** to load the selected application version and reboot the receiver.
- Step 3** Click **Erase** to remove the selected application version. You will be prompted to continue or not. Press **OK** to continue the deletion.
- Step 4** Click **Factory Reset** to perform a reset of receiver settings back to the factory set (default) values. A warning message prompts you to confirm the operation. Click **OK** to continue or **No** to cancel the operation.
- Step 5** Click **Reboot Receiver** to reboot the receiver. You will be prompted to verify the operation. Click **Yes** to reboot the receiver or **No** to cancel the operation.

To Change the Download Application

In the **Download APP** section, click **Browse** to select the new version of the D9865 Satellite Receiver's software application. The Choose File dialog opens. Select the upgrade file and click **Open**. Click **Download** to download the selected upgrade file.



CHAPTER 6

Service and Maintenance

This chapter provides additional information on the alarms and warnings of the D9865 Satellite Receiver. It also provides troubleshooting tips. This chapter presents the following major topics:

- [Alarm Messages, page 6-1](#)
- [Warning Messages, page 6-10](#)
- [Troubleshooting, page 6-13](#)

Alarm Messages

The status of the D9865 receiver and its immediate surroundings is reported to the receiver in the form of messages and alarms. You can enable or disable messages in the Alarms & Warnings advanced settings.

The following table shows a list of the available messages and their default alarm status. The Set Messages and Clear Messages are displayed in the Warning History when the messages are set or cleared respectively.

Table 6-1 D9865 Satellite Receiver Alarms

Alarm	Set Message	Cause	Remedy	Severity	Clear Message
Signal Status	Signal is lost	A loss of RF signal occurred.	Check the cables.	Minor	Signal is locked
Signal Status	RF Signal - No Content	The RF tuner is locked, but there is no Transport Stream content.	Check the cables.	Minor	
Signal Status	Tuning Parameters Invalid	Invalid frequency or other tuning parameters.	Check tuning parameters.	Minor	Tuning Parameters Valid
Program Not Auth	Channel is not authorized	The channel is unauthorized for the current program because the tier bits do not match.	Contact your (uplink) service provider to determine whether you are authorized to receive the current program.	Minor	Channel is authorized

Alarm Messages

Alarm	Set Message	Cause	Remedy	Severity	Clear Message
Program Not Auth	Channel requires an athorization key	The unit does not have an authorization key.	Contact your (uplink) service provider to determine whether you are authorized to receive the current program.	Minor	Channel is authorized
Program Not Auth	Channel is blacked out	The blackout code does not match. A minimum of one blackout code must match.	Contact your (uplink) service provider to determine whether you are authorized to receive the current program.	Minor	Fault Reset
Program Not Auth	Channel uses an unknown CA system	The non-Cisco approved conditional access system is not supported.		Minor	Fault Reset
Program Not Auth	Channel authorization refused	The ISE UA does not match factory configuration.		Minor	Fault Reset
Program Not Auth	Channel requires an IRD with CA support	The conditional access system is not supported.	Obtain an IRD with CA support.	Minor	Fault Reset
Program Not Auth	Channel requires the PE to have an ISE	The in-board security element is not present.	Clear the alarms, reset the unit, and notify Cisco customer support if the problem persists.	Minor	Fault Reset
CAM/CI Slot Status	Initialization Fail	CAM is damaged or not fully inserted.	Re-insert the CAM	Minor	CAM Operation OK
CI Status	Program Not Scrambled	All elementary streams for the selected service for descrambling were not descrambled by the CAM. This is caused by the CAM software crashing, or that you do not have subscription rights for the smart card.	Re-insert the CAM and/or ensure you have the subscription rights for the smart card.	Minor	Descrambling OK
Shutdown Event	DL APP REBOOT	New application is downloaded and the system requires a reboot.	Clear alarms, reset the unit, and notify Cisco customer support if the problem persists.	Major	None.
Shutdown Event	J2C Failure	An internal system error.	Clear alarms, reset the unit, and notify Cisco customer support if the problem persists.	Major	None.

Alarm	Set Message	Cause	Remedy	Severity	Clear Message
Shutdown Event	User requested APP change	User requested a runnable application change, which requires a reboot.	Clear alarms, reset the unit, and notify Cisco customer support if the problem persists.	Major	None.
Shutdown Event	User requested factory reset	User requested a factory reset, which requires a reboot.	Clear alarms, reset the unit, and notify Cisco customer support if the problem persists.	Major	None.
Shutdown Event	User requested reboot	User requested a reboot.	Clear alarms, reset the unit, and notify Cisco customer support if the problem persists.	Major	None.
Shutdown Event	PRODUCTION - Protect Flash	A reboot is required after production tables are removed.	Clear alarms, reset the unit, and notify Cisco customer support if the problem persists.	Major	None.
Shutdown Event	WDOG requesting shutdown shell command	User entered command requesting shutdown	Clear alarms, reset the unit, and notify Cisco customer support if the problem persists.	Major	None.
Shutdown Event	WDOG shutdown shell command	User entered command requesting shutdown	Clear alarms, reset the unit, and notify Cisco customer support if the problem persists.	Major	None.
Shutdown Event	osal_SetDataForAllTasks	Application initialization error caused by a possible software issue.	Clear alarms, reset the unit, and notify Cisco customer support if the problem persists.	Major	None.
Shutdown Event	aw_LoadFaultList	Application initialization error caused by a possible software issue.	Clear alarms, reset the unit, and notify Cisco customer support if the problem persists.	Major	None.
Shutdown Event	osal_Init	Application initialization error caused by a possible software issue.	Clear alarms, reset the unit, and notify Cisco customer support if the problem persists.	Major	None.
Shutdown Event	NVS FLASH mounted	Application initialization error caused by a possible software issue.	Clear alarms, reset the unit, and notify Cisco customer support if the problem persists.	Major	None.
Shutdown Event	DB_Table_Cl::populateNvsRecords	Application initialization error caused by a possible software issue.	Clear alarms, reset the unit, and notify Cisco customer support if the problem persists.	Major	None.

Alarm Messages

Alarm	Set Message	Cause	Remedy	Severity	Clear Message
Shutdown Event	STAPI_Init	Application initialization error caused by a possible software issue.	Clear alarms, reset the unit, and notify Cisco customer support if the problem persists.	Major	None.
Shutdown Event	DB_Array32_CI init failed	Application initialization error caused by a possible software issue.	Clear alarms, reset the unit, and notify Cisco customer support if the problem persists.	Major	None.
Shutdown Event	DB_FlagArray32_CI init failed	Application initialization error caused by a possible software issue.	Clear alarms, reset the unit, and notify Cisco customer support if the problem persists.	Major	None.
Shutdown Event	Wrong DB Item detected: item = AAA, table = BBB	Application initialization error caused by a possible software issue.	Clear alarms, reset the unit, and notify Cisco customer support if the problem persists.	Major	None.
Shutdown Event	DB_Item_CI::addItem() failed	Application initialization error caused by a possible software issue.	Clear alarms, reset the unit, and notify Cisco customer support if the problem persists.	Major	None.
Shutdown Event	Memory allocation error on DB table construction	Application initialization error caused by a possible software issue.	Clear alarms, reset the unit, and notify Cisco customer support if the problem persists.	Major	None.
Shutdown Event	DB_Table_CI::addTable() failed	Application initialization error caused by a possible software issue.	Clear alarms, reset the unit, and notify Cisco customer support if the problem persists.	Major	None.
Shutdown Event	DB_Table_CI::addItem() failed: too many DB Items	Application initialization error caused by a possible software issue.	Clear alarms, reset the unit, and notify Cisco customer support if the problem persists.	Major	None.
Shutdown Event	DBT Init Failed: AAA	Application initialization error caused by a possible software issue.	Clear alarms, reset the unit, and notify Cisco customer support if the problem persists.	Major	None.
Shutdown Event	Framework Registration Error	Application initialization error caused by a possible software issue.	Clear alarms, reset the unit, and notify Cisco customer support if the problem persists.	Major	None.
Shutdown Event	7109 exception! Code = X, Address = Y, Task = Z	Application initialization error caused by a possible software issue.	Clear alarms, reset the unit, and notify Cisco customer support if the problem persists.	Major	None.

Alarm	Set Message	Cause	Remedy	Severity	Clear Message
Shutdown Event	Memory Error: AAA, Phase X	Application initialization error caused by a possible software issue.	Clear alarms, reset the unit, and notify Cisco customer support if the problem persists.	Major	None.
Shutdown Event	Product Control table creation failed	Application initialization error caused by a possible software issue.	Clear alarms, reset the unit, and notify Cisco customer support if the problem persists.	Major	None.
Shutdown Event	Product Config table creation failed	Application initialization error caused by a possible software issue.	Clear alarms, reset the unit, and notify Cisco customer support if the problem persists.	Major	None.
Shutdown Event	MAC Address table creation failed	Application initialization error caused by a possible software issue.	Clear alarms, reset the unit, and notify Cisco customer support if the problem persists.	Major	None.
Shutdown Event	HW Data table creation failed	Application initialization error caused by a possible software issue.	Clear alarms, reset the unit, and notify Cisco customer support if the problem persists.	Major	None.
Shutdown Event	PCB table creation failed	Application initialization error caused by a possible software issue.	Clear alarms, reset the unit, and notify Cisco customer support if the problem persists.	Major	None.
Shutdown Event	FPGA Settings table creation failed	Application initialization error caused by a possible software issue.	Clear alarms, reset the unit, and notify Cisco customer support if the problem persists.	Major	None.
Shutdown Event	Prod Aud Tbl creation failed	Application initialization error caused by a possible software issue.	Clear alarms, reset the unit, and notify Cisco customer support if the problem persists.	Major	None.
Shutdown Event	Prod FE Tbl creation failed	Application initialization error caused by a possible software issue.	Clear alarms, reset the unit, and notify Cisco customer support if the problem persists.	Major	None.
Shutdown Event	Product Version table creation failed	Application initialization error caused by a possible software issue.	Clear alarms, reset the unit, and notify Cisco customer support if the problem persists.	Major	None.
Shutdown Event	Product User Address table creation failed	Application initialization error caused by a possible software issue.	Clear alarms, reset the unit, and notify Cisco customer support if the problem persists.	Major	None.

Alarm Messages

Alarm	Set Message	Cause	Remedy	Severity	Clear Message
Shutdown Event	Product Reference Number table creation failed	Application initialization error caused by a possible software issue.	Clear alarms, reset the unit, and notify Cisco customer support if the problem persists.	Major	None.
Shutdown Event	Time Control object creation failed	Application initialization error caused by a possible software issue.	Clear alarms, reset the unit, and notify Cisco customer support if the problem persists.	Major	None.
Shutdown Event	Wrong UIC Item detected: item = AAA, table BBB	Application initialization error caused by a possible software issue.	Clear alarms, reset the unit, and notify Cisco customer support if the problem persists.	Major	None.
Shutdown Event	Memory allocation error on UIC table construction	Application initialization error caused by a possible software issue.	Clear alarms, reset the unit, and notify Cisco customer support if the problem persists.	Major	None.
Shutdown Event	Error adding UIC table(AAA)	Application initialization error caused by a possible software issue.	Clear alarms, reset the unit, and notify Cisco customer support if the problem persists.	Major	None.
Shutdown Event	UD - ud_init_phase_4() FAILED to allocate memory from System Partition	Application initialization error caused by a possible software issue.	Clear alarms, reset the unit, and notify Cisco customer support if the problem persists.	Major	None.
Shutdown Event	FW: Memory or List Full	Internal system error.	Clear alarms, reset the unit, and notify Cisco customer support if the problem persists.	Major	None.
Shutdown Event	Framework Registration Error	Internal system error.	Clear alarms, reset the unit, and notify Cisco customer support if the problem persists.	Major	None.
Shutdown Event	WDOG task: watchdog aud st wdog has expired	The software detected an error in operation.	Clear alarms, reset the unit, and notify Cisco customer support if the problem persists.	Major	None.
Shutdown Event	WDOG task: watchdog MC OCM has expired	The software detected an error in operation.	Clear alarms, reset the unit, and notify Cisco customer support if the problem persists.	Major	None.
Shutdown Event	WDOG task: watchdog MC SCRIPT has expired	The software detected an error in operation.	Clear alarms, reset the unit, and notify Cisco customer support if the problem persists.	Major	None.

Alarm	Set Message	Cause	Remedy	Severity	Clear Message
Shutdown Event	WDOG task: watchdog Secondary WD has expired	The software detected an error in operation.	Clear alarms, reset the unit, and notify Cisco customer support if the problem persists.	Major	None.
System Startup	System Startup	Restarted the D9865 Satellite Receiver.	None. It will automatically reset after 1 second.	Minor	Backup/Restore System Startup.
LMI Setup	LMI SDRAM exhaust test failed	DDR RAM on LMI bus not working due to a hardware issue.	Clear alarms, reset the unit, and notify Cisco customer support if the problem persists.	Major	LMI Video SDRAM exhaust test passed
Param Storage	DB NVS flushing ignored	Non-volatile storage system failed to fully update due to a hardware issue.	Clear alarms, reset the unit, and notify Cisco customer support if the problem persists.	Major	DB flushing completed
Param Storage	RAM flush to NVS failed	Non-volatile storage system failed to fully update due to a hardware issue.	Clear alarms, reset the unit, and notify Cisco customer support if the problem persists.	Major	DB flushing completed
Param Storage	DB Factory Reset failed	Non-volatile storage system failed during factory reset.	Clear alarms, reset the unit, and notify Cisco customer support if the problem persists.	Major	DB Factory Reset completed
Flash Storage	RECORD: init failed	Non-volatile storage system corrupted due to a hardware issue. There is a possible loss of configuration.	Clear alarms, reset the unit, and notify Cisco customer support if the problem persists.	Major	RECORD: init done
Flash Storage	RECORD MANAGER: Record contents check error, erasing all	NVS corruption and loss of configuration data due to a hardware issue.	Clear alarms, reset the unit, and notify Cisco customer support if the problem persists.	Major	
Flash Storage	RECORD: sector setup check error, erasing sector	NVS Corruption and loss of sector data due to a hardware issue.	Clear alarms, reset the unit, and notify Cisco customer support if the problem persists.	Major	
LNB PS	LNBPS: No Load	LNB power overload due to a hardware or wiring issue.	Clear alarms, check LNB and wiring. Notify Cisco customer support if the problem persists.	Minor	LNBPS: Normal
LNB PS	LNBPS: Over Temperature	LNB power overload due to a hardware or wiring issue.	Clear alarms, check LNB and wiring. Notify Cisco customer support if the problem persists.	Minor	LNBPS: Disabled

Alarm Messages

Alarm	Set Message	Cause	Remedy	Severity	Clear Message
LNB PS	LNBPS: Over Loaded	LNB power overload due to a hardware or wiring issue.	Clear alarms, check LNB and wiring. Notify Cisco customer support if the problem persists.	Minor	
LNB PS	LNBPS: Short Circuit	LNB power overload due to a hardware or wiring issue.	Clear alarms, check LNB and wiring. Notify Cisco customer support if the problem persists.	Minor	LNBPS: Off
DiSEqC HW Fault	DiSEqC Hardware Fault	Unable to send DiSEqC commands to external equipment. due to a hardware issue.	Clear alarms, check LNB and wiring. Notify customer support if the problem persists. Ensure LNB power is on (even if using external LNB power) and DiSEqC is enabled.	Minor	None. It automatically clears after a few seconds.
Signal Quality	Audio Muted due to RF noise	RF Signal quality is poor due to interference or signal level issues.	Check RF settings, re-aim dish, and add signal amplifier.	Minor	Audio Unmuted
Signal Quality	Unstable RF Signal	Signal lock status is toggling frequently.	Check RF settings, re-aim dish, and add signal amplifier.	Minor	Signal Quality Fault Cleared
Signal Quality	Poor Quality RF Signal	Signal is locked but BER is beyond muting threshold.	Check RF settings, re-aim dish, and add signal amplifier.	Minor	Signal Quality Fault Cleared
Transport Processing	PTI lockup	Programmable transport input module stopped processing any data packet. due to a software issue.	Clear alarms, reset unit, and notify Cisco customer support if the problem persists	Minor	PTI running
DL Write/Erase Fault	APP Flash Write Failed	Downloaded application CRC check failed or failed to write application to flash.	None. Fault will reset in 30 seconds. Notify customer support if the problem persists.	Major	None.
Boot Host	KB not accessible	KB is not detected by Boot code due to a hardware issue.	Clear alarms, reset unit, and notify customer support if the problem persists.	Major	
Boot Host	FLASH Not Found	Flash memory not detected due to a hardware issue.	Clear alarms, reset unit, and notify customer support if the problem persists.	Major	
Boot Host	BOOT Invalid	Boot software cannot be read from memory correctly due to a hardware issue.	Clear alarms, reset unit, and notify customer support if the problem persists.	Major	BOOT passed

Alarm	Set Message	Cause	Remedy	Severity	Clear Message
Boot Host	APP Invalid	Application software cannot be read from memory correctly due to a hardware issue.	Clear alarms, reset unit, and notify customer support if the problem persists.	Major	
MPE alarm	Data lost, transport error	Transport error indicator is set in the transport stream.	Verify that the uplink is in good condition.	Major	None.
MPE alarm	Data lost, CRC error	CRC error detected in MPE stream.	Verify that the uplink is in good condition.	Major	None.
MPE alarm	Data lost, CC error	CC error detected in MPE stream.	Verify that the uplink is in good condition.	Major	None.
MPE alarm	Data lost, buffer overflow	Buffer overflow detected in MPE stream.	Reduce MPE rate.	Major	None.
MPE alarm	Data lost, bad sections	Bad section data detected in MPE stream, due to original data or overflow issue.	Verify uplink is in good condition and/or reduce MPE rate.	Major	None.
MPE alarm	Data lost, MPE capacity exceeded	Bit rate controller dropping data due to CPU load limitations.	Reduce MPE rate.	Major	None.
MPE alarm	MPE capacity is reached.	Unit is busy processing or handling other services.	Reduce service load.	Major	None.
LEC Timeout	LEC Table Missing/timeout: channels currently unavailable	LEC table is missing or not received due to the LEC table missing in the signal.	Verify that the uplink is sending LEC tables.	Major	LEC received

Warning Messages

Table 1-2 displays a list of the available messages and their default warning status.

Table 6-2 D9865 Satellite Receiver Warning Messages

Warning	Set Message	Cause	Remedy	Clear Message
Transport Error	Continuity Count Error	Transport packet continuity count jumped due to a possible uplink or signal issue. Possible packet loss.	Clear warnings, reset the unit, and notify Cisco customer support if the problem persists.	Continuity Count Error Cleared
Transport Error	Buffer Overflow	The transport stream is faster than the maximum buffer or the decode engines are having difficulty handling the data sent to them. This is due to a possible uplink or signal issue.	Clear warnings, reset the unit, and notify Cisco customer support if the problem persists.	Buffer Overflow Cleared
Transport Error	Transport Error Indicator	Transport packets are marked as “errored” upstream of the decoder due to a possible uplink or signal issue.	Clear warnings, reset the unit, and notify Cisco customer support if the problem persists.	Transport Error Indicator Cleared
Video Format Mismatch	Video format mismatch	The video format is mismatched.	None.	Video format match
VBI Data	2nd VBI PID attempt to write same line	Conflicting VBI data on second VBI PID due to an uplink configuration issue.	Contact uplink to verify expected VBI settings.	Line Collision Cleared
TDT/SDT/PMT/PAT/NIT/CAT/ECT timeout	tdt/nit/cat/ect timed out sdt/pmt/pat # timed out	Uplink is not sending or is sending intermittently.	Clear warning. If the problem persists, determine if uplink is sending the current SI information table. Disable the warning if not using the table.	tdt/sdt/pmt/pat/nit/cat/ect fault cleared
TDT/SDT/PMT/PAT/NIT/CAT/ECT timeout	tdt/sdt/pmt/pat/nit/cat/ect is lost	Uplink is not sending or is sending intermittently.	Clear warning. If the problem persists, determine if uplink is sending the current SI information table. Disable the warning if not using the table.	tdt/sdt/pmt/pat/nit/cat/ect fault cleared

Warning	Set Message	Cause	Remedy	Clear Message
Memory Usage Host	Excessive (stack/partition) memory usage	SW exceeding allowable memory usage due to a software issue.	Clear warnings, reset the unit, and notify customer service if the problem persists.	Normal (stack/partition) memory usage
MPE near capacity	Approaching current capacity	Decoder is busy processing or handling other services and it is approaching the limit of safe CPU load for MPE processing.	Reduce or stop MPE service content.	None.
Ethernet MAC Failure	MAC configuration failed	Errors, such as a Fatal Bus Error, due to a possible hardware issue.	Clear warnings, reset the unit, and notify customer service if problem persists.	Failure cleared
Ethernet PHY Failure	Marvel switch configuration failed	Related to MII register read/write failures, due to a possible hardware issue.	Clear warnings, reset the unit, and notify Cisco customer support if the problem persists.	PHY failure monitoring reset
Ethernet Port 1 or Ethernet Port 2	ETH Port 1 or 2 Link Down	Ethernet port 1 or 2 is not connected.	Connect Ethernet port 1 or 2.	ETH Port 1 or 2 Link Up
FW: Resource Use PRI	Memory or List Near Full	Software exceeding allowable usage of internal constructs, due to a possible software issue.	Clear warnings, reset the unit, and notify Cisco customer support if the problem persists.	None.
Backup Operation State	Backup Active	Backup operation started.	None.	Backup Complete
Backup Failure Reason	Internal Error	Software error occurred due to a possible software issue.	Clear warning, reset the unit, and notify Cisco customer support if the problem persists.	Auto reset after timeout
Backup Failure Reason	FTP Failed	FTP failed due to a possible software issue.	Check FTP configuration, reset unit, and notify Cisco customer support if problem persists.	Auto reset after timeout
Restore Failure Reason	Not Accepted	Software error occurred due to a possible software issue.	Clear warning, reset the unit, and notify Cisco customer support if the problem persists.	Auto reset after timeout
Restore Failure Reason	Bad Content	Software error occurred due to a possible software issue.	Clear warning, reset the unit, and notify Cisco customer support if the problem persists.	Auto reset after timeout

Warning Messages

Warning	Set Message	Cause	Remedy	Clear Message
Restore Failure Reason	FTP Failed	FTP failed due to a possible software issue.	Check FTP configuration, reset unit, and notify Cisco customer support if problem persists.	Auto reset after timeout
HDMI:Not an Auth Device	HDCP authentication failed	HDMI monitor is not authorized to receive HDMI content and does not contain valid HDCP keys. Video decode is disabled.	Disconnect HDMI monitor to restore video decode or use an HDMI monitor that properly supports HDCP. HDMI monitor is not connected. Connect an HDMI or DVI capable monitor, if desired.	HDCP authentication success
HDMI:Not an Auth Device	Receiver not HDCP capable	HDMI monitor is not authorized to receive HDMI content and it does not support HDCP. Video decode is disabled.	Disconnect HDMI monitor to restore video decode or use an HDMI monitor that properly supports HDCP.	HDCP Authentication Process Not Started
TV-Out Settings Problem	Invalid configuration data	Incorrect TV-Out video setup settings.	Check the video setup settings: TV Channel Number and SD Video Output format. For PAL device, use channel 21 through 69 and SD Format PAL-x. For NTSC device, use channel 3 or 4 and SD Format NTSC or NTSC-J. Notify customer service if problem persists.	Valid configuration data

Troubleshooting

If you experience any problems operating your satellite receiver, the following table may help you resolve your problem.

Problem	Cause	Remedy
Blank screen (TV switched on)	Normal operation if receiver is not on (power switch on back panel).	Press the Display button on the receiver front panel or remote control.
Scrambled channel (not decoded)	Subscriber services may not be authorized for the channel.	Check that your subscriber services are currently authorized (contact your service provider).
Cannot access a password protected on-screen option	You have entered an incorrect password or the password has been changed.	Check that you are using the correct password. If the password is lost or unavailable, contact your local service provider.
Remote Control not operating properly	The remote control may be defective, or the batteries are incorrectly installed, or require replacement.	Replace or correctly install the remote control batteries.
Program Not Authorized message is displayed	Subscriber services are not authorized for selected channel.	Check that your subscriber services are authorized by viewing signal status on the Dish Setup menu (or contact your service provider).
Authorization Key Not Received message is displayed	Subscriber services are not authorized due to authorization key not being received.	Same as above.
No signal	Installation or signal problem.	Check connections to receiver, dish alignment and/or tuning setup.
Blank (black) screen is displayed after exiting to video from menus	Channel 0 is displayed after exiting to video following changes made to the current receiver setup.	Press CH+ or CH- on remote control to display channels.
Poor reception	The following are the possible causes: <ul style="list-style-type: none"> Receiver is not properly set up or connected to receive satellite signal. Possible station trouble. Signal source for one or more (or all) channels is temporarily affected by technical transmission problems or a temporary solar disturbance. Satellite dish may not be properly installed or is not accurately aimed at satellite signal. 	The following are the possible solutions: <ul style="list-style-type: none"> Check the connections to and from satellite antenna LNB, television antenna, and all video and audio cables (see <Quick Setup Instructions, page 1-2>). Check another channel to compare signal reception. Check that a maximum Signal Level is achieved or displayed when aligning the dish.

Problem	Cause	Remedy
No picture or sound	<p>The following are the possible causes:</p> <ul style="list-style-type: none"> You have not turned your receiver on or the receiver is not properly connected to the AC power. Your antenna, video and/or audio cables may be faulty or not properly connected. 	<p>The following are the possible solutions:</p> <ul style="list-style-type: none"> Possible station trouble. The signal source for one or more channels is temporarily affected by transmission problems or due to a temporary solar disturbance. Press the Display button on the receiver front panel or remote control. Check that the receiver is properly connected to the AC power. Check the connections to the satellite antenna LNB, television antenna, and all video and audio cables. Check another channel to compare signal reception.
No sound	<p>The following are the possible causes:</p> <ul style="list-style-type: none"> The sound has been muted. Audio cable may be faulty or not properly connected. Possible station trouble. The signal source for one or more channels is temporarily affected by transmission problems or due to a temporary solar disturbance. Digital Audio setting is not configured properly. 	<p>The following are the possible solutions:</p> <ul style="list-style-type: none"> Same as above. Check that the volume is not muted by pressing the VOL+ or VOL- button on the remote control. Check another channel to compare signal reception. Check the Digital Audio setting in the Audio Setup screen. For example, if it is set to Dolby Digital, ensure that your system supports compressed audio.
Poor picture	Same as above.	Check another channel to compare signal reception.



APPENDIX **A**

Technical Specifications

This appendix contains the technical specifications for the D9865 Satellite Receiver. The technical specifications are subject to change without prior notice.

This appendix includes the following sections:

- [Receiver Specifications, page A-1](#)
- [LNB Requirements, page A-2](#)
- [DVB-S Eb/No \(C/N\) Ratio, page A-3](#)
- [DVB-S2 Error Rate Performance ES/No \(C/N\) Ratio, page A-3](#)
- [Video Output, page A-4](#)
- [Audio Outputs, page A-5](#)
- [Power, page A-5](#)
- [General, page A-6](#)

Receiver Specifications

General

Parameter	Specification
System	MPEG-2/DVB Compatible EN300 420, EN 300468, H.264
Demodulation	DVB-S QPSK, DVB-S2 QPSK and 8PSK
Number of RF Inputs	1

Tuner

Parameter	Specification
Number of RF Inputs	1
Input Level	-25 dBm to -65 dBm per carrier
Frequency Range	950 MHz to 2150 MHz
Symbol Rate Range	DVB-S: 1.0 to 45 MS/s DVB-S2: 1.0 to 31 MS/s
Satellites	C-band and Ku-band
Receiver Spectrum Sense	Normal and Inverted
Input Impedance	75 Ω

LNB Requirements

DVB-S and DVB-S2

Symbol Rate	Stability
1 to 2.99 MS/s	$\leq \pm 0.125$ MHz
3 to 5.99 MS/s	$\leq \pm 1.00$ MHz
6 to 11.99 MS/s	$\leq \pm 3.00$ MHz
12 to 45 MS/s	$\leq \pm 5.00$ MHz

Parameter	Specification
LNB Phase Noise Requirement	-28 dBc/Hz at $\delta F = 100$ Hz -53 dBc/Hz at $\delta F = 1$ kHz -76 dBc/Hz at $\delta F = 10$ kHz -93 dBc/Hz at $\delta F = 100$ kHz -106 dBc/Hz at $\delta F = 1$ MHz -117 dBc/Hz at $\delta F = 10$ MHz

DVB-S Eb/No (C/N) Ratio

Convolutional FEC Rate	Eb/No Ratio (dB) in Linear Channel and IF Loop configuration	C/N at DVB Threshold (BW = Symbol Rate)
1/2	4.5	4.1
2/3	5.0	5.9
3/4	5.5	6.9
5/6	6.0	7.9
7/8	6.4	8.5

Note

The D9865 receiver displays the C/N Ratio.

$$C/N = Eb/No + 10 \log (2 \times FEC \times 188/204)$$

DVB-S2 Error Rate Performance ES/No (C/N) Ratio

Mode	Simulated Es/No (dB) for FEC Frame length = 64,800	Typical Performance (dB) in Linear Channel and IF Loop Configuration
QPSK 1/2	1.00	1.2
QPSK 3/5	2.23	2.4
QPSK 2/3	3.10	3.2
QPSK 3/4	4.03	4.2
QPSK 4/5	4.68	4.8
QPSK 5/6	5.18	5.3
QPSK 8/9	6.20	6.4
QPSK 9/10	6.42	6.6
8PSK 3/5	5.50	5.8
8PSK 2/3	6.62	6.8
8PSK 3/4	7.91	8.1
8PSK 5/6	9.35	9.6
8PSK 8/9	10.69	10.9
8PSK 9/10	10.98	11.3

**Note**

“Typical performance” was measured with Pilots On. Pilots On is highly recommended as the performance values typically degrade up to 0.9 dB with Pilots Off. Pilots On must be used for 8PSK 3/5, 8PSK 2/3 and 8PSK 3/4.

Video Output

Analog Video Output

Parameter	Specification
Number of channels	1
Connector Type	RCA
Video Compression Type	MPEG-2 4:2:0 MPEG-4 4:2:0
Level	1.0V pp \pm 10%
Video Standard	NTSC & PAL B/G/I/D/M/N/J, supports HD downconversion

Digital Audio/Video Output (D9865H and D9865D only)

Parameter	Specification
Number of Outputs	One HDMI digital audio/video output, supports SD-to-HD upconversion

HD Analog Video Output (D9865H and D9865D only)

Parameter	Specification
Number of Outputs	One component (Y, Pb, Pr) HD analog video output

Audio Outputs

Analog Audio Output

Parameter	Specification
Number of Channels	1 stereo pair/2 mono channels
Connector Type	RCA
Output Level	Unbalanced, 2 V rms \pm 10% at 0 dBFS
Audio Decompression	MPEG 1 Layer 2, Dolby Digital Plus, HE-AAC

Digital Audio S/PDIF Output

Parameter	Specification
Connector Type	RCA
Output Impedance	75 Ω +/-20%, from 0.1 MHz to 6.0 MHz
Signal Amplitude	0.5V +/-20% at 75 Ω

VBI

Parameter	Specification
NTSC	Lines 10 to 22 fields 1 and 2
PAL	Lines 7 to 22 fields 1 and 2 WST, WSS, VPS

Power

AC Power Connector

Parameter	Specification
Voltage Range	100 V to 240 V AC
Line Frequency	50/60 Hz
Power Consumption	35 W max.
LNB Power on satellite input	+13 V/+ 18 V @ 350 mA max.

General

Mechanics

Parameter	Specification
Height	2.36 in. (6.0 cm)
Width	11.69 in. (29.7 cm)
Depth	7.68 in. (19.5 cm)
Weight	5 lbs (2.3 kg)

Environment

Parameter	Specification
Operating Temperature	0°C to 50°C (32°F to 122°F)
Storage	-20°C to 70°C (-4°F to 158°F)



APPENDIX **B**

Default Settings

This appendix contains the factory default settings for the D9865 Satellite Receiver. The D9865 Satellite Receiver is factory configured with default settings unless you have requested a custom factory configuration.

This appendix includes the following sections:

-

Factory Default Settings

Tuning/Preset

Parameter	Default
Modulation Type	DVB-S2
Downlink	12.3 GHz
Symbol Rate	30.0 MS/s
Net Id	1
LO Select	Off
LO Freq 1	10.75 GHz
LO Freq 2	0.0 GHz
Crossover	0.0 GHz
LNB Power	18V
DiSEqC	Disable
DiSEqC Switch	Off
Roll Off Factor (Web-GUI only)	.35
I/Q (Web GUI only)	Auto

Preset - Number 1

Parameter	Default
Preset Number	1
Preset Name	ET
LNB Configuration	1
Modulation Type	DVB-S
Downlink	11.795 GHz
Symbol Rate	20.0 MS/s
NetId	7

Preset Number 2

Parameter	Default
Preset Number	2
Preset Name	Enterprise
LNB Configuration	1
Modulation Type	DVB-S
Downlink	11.851 GHz
Symbol Rate	30.5 MS/s
NetId	3

Preset - Number 3

Parameter	Default
Preset Number	3
Preset Name	Exterminator
LNB Configuration	1
Modulation Type	DVB-S
Downlink	12.15 GHz
Symbol Rate	28.3465 MS/s
NetId	6

Preset - Number 4

Parameter	Default
Preset Number	4
Preset Name	Spiderman
LNB Configuration	1
Modulation Type	DVB-S
Downlink	12.25 GHz
Symbol Rate	30.8 MS/s
NetId	1

Preset - Number 5

Parameter	Default
Preset Number	5
Preset Name	Effete
LNB Configuration	1
Modulation Type	DVB-S2
Downlink	12.31 GHz
Symbol Rate	30.0 MS/s
NetId	1

Preset - Number 6

Parameter	Default
Preset Number	6
Preset Name	Encounter
LNB Configuration	1
Modulation Type	DVB-S
Downlink	12.39 GHz
Symbol Rate	45.00 MS/s
NetId	4

Preset - Number 7

Parameter	Default
Preset Number	7
Preset Name	Ebenezer
LNB Configuration	1
Modulation Type	DVB-S
Downlink	12.45 GHz
Symbol Rate	30.5 MS/s
NetId	1

Preset - Number 8

Parameter	Default
Preset Number	8
Preset Name	Big Originator
LNB Configuration	1
Modulation Type	DVB-S
Downlink	12.604 GHz
Symbol Rate	28.3465 MS/s
NetId	5

Preset - Number 9 to 63

Parameter	Default
Preset Number	9 to 63
Preset Name	Network name
LNB Configuration	1
Modulation Type	DVB-S
Downlink	12.25 GHz
Symbol Rate	10.0 MS/s
NetId	1

Preset - Number 64

Parameter	Default
Preset Number	64
Preset Name	Network name
LNB Configuration	10
Modulation Type	DVB-S2
Downlink	12.30 GHz
Symbol Rate	30 MS/s
NetId	1

LNB Setup - Configuration 1 to 9

Parameter	Default
LNB Configuration	1 to 9
LNB Power	Off
LO Freq1	5.15 GHz
LO Freq2	0.0 GHz
Crossover	0.0 GHz
LO Select	Off
DiSEqC	Disable
DiSEqC Switch	Off

LNB Setup - Configuration 10

Parameter	Default
LNB Configuration	10
LNB Power	18-H
LO Freq1	10.75
LO Freq2	0.0 GHz
Crossover	0.0 GHz
LO Select	Off
DiSEqC	Disable
DiSEqC Switch	Off

Video Setup

Parameter	Default
HD Video Output	Auto
SD Video Output	For NTSC Unit: NTSC For PAL Unit: PAL-B
TV Channel	For NTSC: 3 For PAL: 21
TV Aspect Ratio	4:3
Aspect Ratio Convert	None
Closed Caption	Auto
Wide Screen Signalling (Web GUI only)	Auto Create
Enable Banner Display (Web GUI only)	Enabled

Subtitle Setup

Parameter	Default
Subtitle Control	Off
Imitext Color	Auto
Imitext Shade	Auto
Imitext Position	Standard
Subtitle Language	eng
Language Entry (Web GUI only)	eng
PMT Order (Web GUI only)	First

Audio Setup

Parameter	Default
Stereo/Mono	Stereo
DRC Mode	RF Mode
Digital Audio Preference	PCM
Audio PMT Source	AUD1

Administration

Parameter	Default
POV mode	Std
Lock level	0
Menu transparency	None
IR remote	Enable
Date format	YYYY-MM-DD
Time format	24 Hour
Time offset	+05:30

POV Mode

Parameter	Default
CA Mode	Std
Acquisition Mode	Basic
Tuning Source	NIT
Service List Mode	Rigorous
BAT	No
NIT	Yes
SDT	Yes
PAT	Yes

Advanced Administration

Parameter	Default
Set Lock Level Password	1234

IP Setup

Parameter	Default
Filter Mode	Forward All
MPE Optimization	High Bitrate

Unicast IP Setup

By default, the Unicast routes list is empty.

Multicast IP Setup

By default, the Multicast routes list is empty.

Trap Destination Setup

Parameter	Default
Voltage Range	100 V to 240 V AC
Line Frequency	50/60 Hz
Power Consumption	35 W max.
LNB Power on satellite input	+13 V/+ 18 V @ 350 mA max.

SNMP

Parameter	Default
Read Community String	public
Write Community String	public
System Name (Web GUI only)	sysname
System Location (Web GUI only)	Toronto
System Contact (Web GUI only)	416-321-XXXX

Noise Cutoffs

Parameter	Default
Noise Cutoffs	Enable
DVB-S/DVB-S2 TS Cut Off	0.0 dB
DVB-S/DVB-S2 TS Restore	0.1 dB
DVB-S/DVB-S2 Audio Cut Off	0.0 dB
DVB-S/DVB-S2 Audio Restore	0.1 dB

Download

Parameter	Default
DL Mode	Always

CI Setup (Web GUI only)

Parameter	Default
Decryption Mode	On
CI CAM QUERY Support	Disable
CI CAM Auto Reset	Disable
CA List Management Type	Update All
TS/ONID Check	Disable
Transport ID	0
Original Network ID	0

Import/Export (Web GUI only)

Parameter	Default
Settings Filename	file name
FTP User Name	User
FTP Password	USER
FTP Port Number	21

Alarms and Warnings

Parameter	Default
AW Banner	Disable



APPENDIX C

Lock Levels

This appendix contains the lock levels for the D9865 Satellite Receiver. This appendix includes the following sections:

-

D9865 Satellite Receiver Lock Levels

Four (4) lock levels (0, 1, 2, 3, and 4) are available for protecting your receiver and its settings against unauthorized use or modification (see the table below for full details).

Level	Description
0	All settings are unlocked (receiver lockout disabled).
1	All settings are unlocked except Preset option.
2	All settings are unlocked except Preset & LNB Setup and Audio/Video options.
3	All settings locked (access via password only).
4	All settings locked (can be changed via PNC uplink signal only).

If a change made to the current Lock Level setting is not saved, the previously saved setting is restored.



Note

The user cannot select NONE as a Lock Level.

Video

Parameter	Lock Level
Channel Up	2
Channel Down	2
Volume Up	3
Volume Down	3

Parameter	Lock Level
Power On/Standby	3
Channel Number via Remote Control	2
IR Mute via Remote Control	3
IR Volume Up	3
IR Volume Down	3
IR Channel Up	2
IR Channel Down	2
IR Last Channel	2
IR FAV key	3
IR NAV key	3
IR EPG key	3
IR Setup key	3
Menu	3

All Screens

Parameter	Lock Level
Power On/Standby	3
IR Mute via Remote Control	3
IR Volume Up	3
IR Volume Down	3
IR Channel Up	2
IR Channel Down	2
IR Last Channel	2

Channel List

Parameter	Lock level
Scroll up and down	3
OK to select channel	2

EPG Grid

Parameter	Lock Level
Scroll up and down	3
Scroll left and right	3
Next Day	3
Previous Day	3
Favorites	3
Timers	3
OK to select channel	2
OK to view future Info	3

EPG Info

Parameter	Lock Level
Set Timer	2

NAVigator Info

Parameter	Lock Level
Set Timer	2

Timers

Parameter	Lock Level
Scroll up and down	3
Delete	2
Edit (to view)	3
Edit (Save button)	2

Favorites

Parameter	Lock Level
Delete	2
New	2
Edit (to view)	3
Edit (Save button)	2
Move	2
Select	2

Edit Favorites

Parameter	Lock Level
Delete	2
Edit (to view)	3
Edit (Save button)	2
Move	2

Timers

Parameter	Lock Level
Delete	2
Edit (to view)	3
Edit (Save button)	2

One Button Channel Change (button presses)

Parameter	Lock Level
Red	2
Green	2
Yellow	2
Blue	2

Tuning/Preset

Parameter	Lock Level
Change Tuning Parameters and Save	1

Tuning/Preset:Preset

Parameter	Lock Level
Change preset number	3
Edit preset tuning parameters	1
Edit preset LNB configuration number	1
Save preset	1
Activate preset	1

Tuning/Preset:Preset:LNB

Parameter	Lock Level
Change LNB configuration number	3
Edit LNB settings	1
Save LNB settings	1

Dish Setup (User Mode)

Parameter	Lock Level
Enter satellite number	1
Select User Action	1
Do Action	1
Enter Installer mode	3

Dish Setup (Installer Mode)

Parameter	Lock Level
Enter satellite number	1
Enter absolute position	1

Parameter	Lock Level
Select installer action	1
Change DiSEqC enable/disable state	1
Adjust dish position	1
Enter user mode	3

Video Setup

Parameter	Lock Level
HD Video Output	2
SD Video Output	2
TV Channel	2
TV Aspect Ratio	2
Aspect Ratio Convert	2
Closed Caption	2

Subtitles

Parameter	Lock Level
Subtitle Control	2
Imitext Color	2
Imitext Shade	2
Imitext Position	2
Subtitle Language	2

Audio Setup

Parameter	Lock Level
Stereo/Mono	2
Dolby Digital Mode	2
Digital Audio Preference	2
Audio PMT Source	2

Administration

Parameter	Lock Level
POV Mode	1
Lock Level	3
Menu Transparency	2
IR Remote	2
Date Format	2
Time Format	2
Time Offset	2

Advanced Administration

Parameter	Lock Level
Set Lock Level Password	0
Reboot	2
Factory Reset (F/R)	0
Rst Login	0

POV Mode

Parameter	Lock Level
CA Mode	1
Acquisition Mode	1
Tuning Source	1
Service List Mode	1
BAT	1
NIT	1
SDT	1
PAT	1

IP Setup

Parameter	Lock Level
Filter Mode	0
MPE Optimization	0
Next Port	2
Set IP Address (button)	2

Change IP Address

Parameter	Lock Level
IP Address	2
Gateway	2
Mask	2
Save	2

Unicast/Multicast IP Setup

Parameter	Lock Level
Add (button)	0
Edit	0
Delete	0

SNMP Setup

Parameter	Lock Level
Read community string	0
Write community string	0
Trap Dest (button)	3

Trap Destinations

Parameter	Lock Level
Add (button)	0
Edit	0
Delete	0

Noise Cutoffs

Lock Level: 2

Alarms and Warnings

Parameter	Lock Level
AW Banner	2
Alarm (button)	3
Warning (button)	3

Alarm/Warning Setup

Lock Level: 2

Download

Parameter	Lock Level
DL Mode	2
Abort DL	2
Restart DL	2
Boot App (button)	3

Bootable App Selection (Screen)

Parameter	Lock Level
Delete	2

Parameter	Lock Level
Load App	2
Safe App	2

Info

Parameter	Lock Level
Service Information (Channel Number)	2
Channel Information (Channel Number)	2
ADP Status (Clear ADP Count)	2
Device Status Information (Clr Rst Count)	2



APPENDIX **D**

Declaration of Conformity

This appendix contains the declaration of conformity for the D9865 Satellite Receiver.



DECLARATION OF CONFORMITY

with regard to the Directives 2006/95/EC (LVD), 2004/108/EC (EMC) and 2011/65/EU (RoHS)

Cisco Systems Inc & all its affiliates

Headquarters:
170 West Tasman Drive
San Jose, CA 95134 - USA

Declare under our sole responsibility that the product,

Brand name: Cisco
Model number: D9865-B / D9865-H / D9865-D
Model name: Satellite Receiver

Fulfills the essential requirements of the Directives 2006/95/EC, 2004/108/EC and 2011/65/EU.

With regard to the Directives 2006/95/EC and 2004/108/EC, and 2011/65/EU the following standards were applied:

Number and Date of Issue	Title of Standard
EN 60065:2002/A11:2008 +A2:2010+A12:2011	- Audio, video and similar electronic apparatus – Safety requirements
EN 55022:2006 / A1:2007 Class B	- Limits and Methods of Measurement of Radio Interference Characteristics of Information Technology Devices
EN 55013:2001/ A1:2003 / A2:2006	- Electromagnetic Compatibility Requirements - Sound and Television Broadcast Receivers and Associated Equipment
EN 55020:2007	- Sound and television broadcast receivers and associated equipment – Immunity characteristics – Limits and methods of measurement
EN 55024:1998 /A1:2001 / A2:2003	- Information technology equipment - Immunity characteristics - Limits and methods of measurement
EN 61000-3-2: 2006+A1+A2	- Electromagnetic Compatibility - Part 3: Limits Section 2: Limits for Harmonic Current Emissions (Equipment Input Current less than 16A per phase)
EN 50581: 2012	Technical documentation for the assessment of electrical and electronic products with respect to the restriction of hazardous substances

The product carries the CE Mark, which was first affixed in **2009**:



Date & Place of Issue: 30 October 2012, Scarborough, ON, Canada

Signature(s):

Steven Lawrence
Product Compliance Specialist
Cisco Systems Canada Co.
100 Middlefield Rd.
Scarborough ON M1S4M6
Canada

EU Authorized Representative:

Edgard Vangeel
Cisco Systems Belgium
De Kleetlaan, 6 A
B 1831 Diegem - Belgium

D9865_Cisco_DMN_EU_DOC3.doc





INDEX

A

about window [5-7](#)
AC power connector [A-5](#)
active alarm messages, viewing [4-63](#)
active preset, selecting [4-18](#)
active warning messages, viewing [4-64](#)
actual conversion table [4-28](#)
administration [B-7](#)
administration, advanced default values [B-7](#)
ADP status, viewing [4-67](#)
advanced RF diagnostics, viewing [4-66](#)
advanced settings, viewing [4-35](#)
advanced user settings, setting up [4-36](#)
alarm/warning history, viewing [5-44](#)
alarm messages [6-1](#)
alarms, default values [B-9](#)
alarms, setting up [4-53, 5-42](#)
alarm settings, configure [4-54](#)
alarm status, viewing [5-41](#)
analog audio output [A-5](#)
analog video output [A-4](#)
application version, viewing [4-56](#)
apply [5-6](#)
audio, setting up [4-33, 5-32](#)
audio output [A-4](#)
audio outputs [A-5](#)
audio setup [B-6](#)

B

backup history, viewing [5-47](#)
bootable application selection [4-56](#)

buttons [5-6](#)

C

CAM [3-3, 3-4](#)
captions, configuring [5-29](#)
channel, browsing [4-5](#)
channel information, setting [5-20](#)
channel information, viewing [4-60](#)
channel list without EPG [4-4](#)
channels, changing [4-7](#)
channel scan [4-12](#)
CI information, configuring [5-21](#)
CI setup, default values [B-9](#)
CI slot [3-3](#)
Common Interface (CI), configuring [5-21](#)
Common Interface Modules [3-4](#)
contact information, viewing [5-53](#)
current channel [4-4, 4-60](#)

D

D9865B Satellite Receiver, rear panel [1-3](#)
D9865D Satellite Receiver, rear panel [1-4](#)
D9865H Satellite Receiver, rear panel [1-4](#)
D9865 settings [5-3](#)
D9865 web GUI environment [5-6](#)
data outputs (D9865D only) [2-1](#)
date, browsing [4-6](#)
Declaration of Conformity [D-1](#)
default settings [B-1](#)
device status information, viewing [4-63](#)
diagnostic logs, viewing [5-53](#)

digital audio/video output (D9865H and D9865D only) [A-4](#)

digital audio preference settings [4-34](#)

digital audio S/PDIF output [A-5](#)

dish pointing, setting up [5-10](#)

DoC [D-1](#)

download, default values [B-9](#)

download application, changing [4-56, 5-45, 5-55](#)

DVB-CI information, viewing [4-62](#)

DVB-S2 error rate performance ES/No (C/N) ratio [A-3](#)

DVB-S and DVB-S2 [A-2](#)

DVB-S Eb/No (C/N) Ratio [A-3](#)

E

EPG [4-5](#)

export, setting up [5-46](#)

F

factory reset [4-39](#)

favorite channels, setting up [4-10](#)

favorite profile, adding [4-10](#)

favorite profile, deleting [4-12](#)

favorite profile, editing [4-11](#)

favorites [4-6, 5-39](#)

favorites profile, editing [5-40](#)

features, viewing [5-34](#)

filter mode, setting [4-43](#)

Free-to-air reception [2-1](#)

front panel [3-1](#)

- LEDs [3-2](#)

H

hardware information, viewing [4-58, 5-46](#)

HD analog video output [A-4](#)

HD video output [4-27](#)

import, setting up [5-46](#)

import/export, default values [B-9](#)

input status, viewing [5-19](#)

installed options, viewing [4-59](#)

installer action mode, setting up the dish [5-11](#)

IP, setting up [5-35](#)

IP address, editing [4-44](#)

IP routing, setting up [5-36](#)

IP setup [4-42](#)

IP setup, default values [B-7](#)

K

keyboard [3-3](#)

L

licenses, viewing [5-34](#)

linked pages [5-5](#)

LNB, setting up [4-19](#)

LNB power settings [4-21](#)

LNB presets, setting up [5-18](#)

LNB requirements [A-2](#)

LNB setup, configuration 10 [B-5](#)

LNB setup, configuration 1 to 9 [B-5](#)

lock level

- EPG grid [C-3](#)

lock level, changing [4-38](#)

lock level, configuring [5-51](#)

lock level password, changing [4-38, 5-52](#)

lock levels [C-1](#)

- administration [C-7](#)
- advanced administration [C-7](#)
- alarm/warning setup [C-9](#)
- alarms and warnings [C-9](#)
- all screens [C-2](#)
- audio setup [C-6](#)

bootable app selection (screen) [C-9](#)
 change IP address [C-8](#)
 channel list [C-2](#)
 dish setup [C-5](#)
 download [C-9](#)
 edit favorites [C-4](#)
 EPG info [C-3](#)
 favorites [C-4](#)
 info [C-10](#)
 IPsetup [C-8](#)
 NAVigator info [C-3](#)
 noise cutoffs [C-9](#)
 one button channel change [C-4](#)
 POV mode [C-7](#)
 SNMP setup [C-8](#)
 subtitles [C-6](#)
 timers [C-3, C-4](#)
 trap destinations [C-9](#)
 tuning/preset [C-5](#)
 unicast/multicast IP setup [C-8](#)
 video [C-1](#)
 video setup [C-6](#)

login [5-2](#)

M

main menu [4-1](#)
 management and data port settings, configuring [5-35](#)
 MIB browser [2-2](#)
 MPE output [4-42](#)
 multicast IP address, adding [4-47](#)
 multicast IP address, deleting [4-48](#)
 multicast IP address, editing [4-48](#)
 multicast IP address, setting [4-47](#)
 multicast IP addresses, viewing [4-47](#)
 multicast IP setup, default values [B-8](#)
 muting threshold controls, setting up [5-15](#)

N

network presets, editing [4-19](#)
 network setup (D9865D only), viewing [4-41](#)
 noise cutoffs, configuring [4-50](#)
 noise cutoffs, default values [B-8](#)
 NTSC [1-1](#)

O

one button channel change, setting up [4-12](#)
 on-screen buttons [4-4](#)
 on-screen display [4-1](#)
 on-screen menus [4-3](#)
 OTA downloads [4-55](#)

P

PAL [1-1](#)
 POV mode, default values [B-7](#)
 POV mode, setting up [4-40](#)
 power [A-5](#)
 power connector [A-5](#)
 preset / LNB, setting up [4-17](#)
 preset 1, default values [B-2](#)
 preset 2, default values [B-2](#)
 preset 3, default values [B-2](#)
 preset 4, default values [B-3](#)
 preset 5, default values [B-3](#)
 preset 6, default values [B-3](#)
 preset 64, default values [B-5](#)
 preset 7, default values [B-4](#)
 preset 8, default values [B-4](#)
 preset 9 to 63, default values [B-4](#)
 PSI channels, viewing [5-27](#)
 PSI frequency information, viewing [5-25](#)
 PSI tables, viewing [5-24](#)

Q

quick setup [1-2](#)

R

rear panel [1-3](#)

reboot receiver [4-39](#)

receiver, rebooting [4-39](#)

refresh [5-6](#)

reminders [5-39](#)

reminder timer from EPG, setting [4-7](#)

remote control [3-4](#)

restore history, viewing [5-47](#)

RF status, viewing [4-65](#)

S

satellite dish, setting up [4-21](#)

satellite position, adjusting in installer mode [4-25](#)

satellite position, adjusting using signal tones [4-25](#)

satellite position, changing in user mode [4-25](#)

satellite receiver startup [1-1](#)

SD video output [4-27](#)

secured broadcast reception [2-1](#)

service actions [5-55](#)

service information, viewing [4-59](#)

setup menu [4-14](#)

 tuning / preset [4-15](#)

signal level [4-26, 4-66](#)

signal lock [4-26](#)

signal quality [4-26, 4-66](#)

signal tones [4-25](#)

SI receive parameters, setting up [5-13](#)

SNMP, default values [B-8](#)

SNMP, setting up [4-48, 5-37](#)

software version, loading [5-55](#)

specifications [A-1](#)

 environment [A-6](#)

 general [A-1](#)

 mechanics [A-6](#)

 tuner [A-2](#)

subscriber services [4-60](#)

subtitles, setting up [4-32, 5-30](#)

subtitle setup [B-6](#)

summary [5-3](#)

system information, viewing [4-57, 5-33](#)

T

time/clock information, configuring [5-38](#)

timer profile, deleting [4-9](#)

timer profile, editing [4-9](#)

timers [4-7](#)

timers, setting [4-7](#)

trap destinations, adding [4-49](#)

trap destinations, editing/deleting [4-50](#)

trap destinations, setting up [5-37](#)

trap destinations, viewing [4-48](#)

trap destination setup, default values [B-8](#)

tuning / preset [4-15](#)

tuning/preset, default values [B-1](#)

tuning information, setting up [5-8](#)

tuning presets/LNB, setting up [5-17](#)

TV video format, setup [3-3](#)

U

unicast IP address, adding [4-45](#)

unicast IP address, deleting [4-46](#)

unicast IP address, editing [4-46](#)

unicast IP address, setting [4-45](#)

unicast IP setup, default values [B-8](#)

usage counters, viewing [5-54](#)

user account, adding [5-49](#)

user account, deleting [5-50](#)

user login passwords, configuring [5-48](#)

V

- VBI [A-5](#)
- version, viewing [5-45](#)
- version information, viewing [4-58](#)
- video, setting up [4-26, 5-28](#)
- video output [A-4](#)
- video output, analog [A-4](#)
- video output restrictions [4-31](#)
- video setup [B-6](#)
- video standard [1-1](#)

W

- warning messages [6-10](#)
- warnings, default values [B-9](#)
- warnings, setting up [4-53, 5-43](#)
- warning settings, configure [4-54](#)
- warning status, viewing [5-41](#)
- web GUI, logging in [5-2](#)
- web GUI accounts, managing [5-48](#)
- web GUI login, resetting [4-40](#)

